

JHS-770S/780D

MARINE VHF RADIOTELEPHONE

**INSTRUCTION
MANUAL**

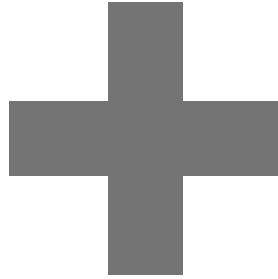

CAUTIONS AGAINST HIGH VOLTAGE

Radio and radar devices are operated by high voltages of anywhere from a few hundred volts up to many hundreds of thousands of volts. Although there is no danger with normal use, it is very dangerous if contact is made with the internal parts of these devices. (Only specialists should attempt any maintenance, checking or adjusting.)

There is a very high risk of death by even a few thousand volts, in some cases you can be fatally electrocuted by just a few hundred volts. To prevent accidents, you should avoid contact with the internal parts of these devices at all costs. If contact is inevitable as in the case of an emergency, you must switch off the devices and ground a terminal in order to discharge the capacitors. After making certain that all the electricity is discharged, only then can you insert your hand into the device. Wearing cotton gloves and putting your left hand in your pocket, in order not to use both hands simultaneously, are also very good methods of shock prevention.

Quite often, an injury occurs by secondary factors, therefore it is necessary to choose a sturdy and level working surface. If someone is electrocuted it is necessary to thoroughly disinfect the affected area and seek medical attention as soon as possible.

Cautions concerning treatment of electrocution victims

When you find an electrocution victim, you must first switch off the machinery and ground all circuits. If you are unable to cut off the machinery, move the victim away from it using a non-conductive material such as dry boards or clothing.

When someone is electrocuted, and the electrical current reaches the breathing synapses of the central nervous system inside the brain, breathing stops. If the victim's condition is stable, he or she can be administered artificial respiration. An electrocution victim becomes very pale, and their pulse can be very weak or even stop, consequently losing consciousness and becoming stiff.

Administration of first aid is critical in this situation.

First aid

☆Note points for first aid

Unless there is impending danger leave the victim where he or she is, then begin artificial respiration. Once you begin artificial respiration, you must continue without losing rhythm.

- (1) Make contact with the victim cautiously, there is a risk that you may get electrocuted.
- (2) Switch off the machinery and then move the victim away slowly if you must.
- (3) Inform someone immediately (a hospital or doctor, dial emergency numbers, etc.).
- (4) Lay the victim on his or her back and loosen any constrictive clothing (a tie, or belt).
- (5)
 - (a) Check the victim's pulse.
 - (b) Check for a heartbeat by pressing your ear against the victim's chest.
 - (c) Check if the victim is breathing by putting the back of your hand or face near the victim's face.
 - (d) Check the pupils of the eyes.
- (6) Open the victim's mouth and remove any artificial teeth, cigarette or chewing gum. Leave the mouth opened and flatten the tongue with a towel or by putting something into the mouth to prevent the victim's tongue from obstructing the throat. (If he or she is clenching the teeth and it is difficult to open the mouth, use a spoon or the like to pry open the mouth.)
- (7) Continually wipe the mouth to prevent the accumulation of saliva.

☆ If the victim has a pulse but is not breathing

("Mouth to mouth" resuscitation) Figure 1

- (1) Place the victim's head facing backward (place something under the neck like a pillow).
- (2) Point the chin upward to widen the trachea.
- (3) Pinch the victim's nose, take a deep breath, then put your mouth over the victim's mouth and exhale completely, making sure that your mouth completely covers the victim's mouth. Then remove your mouth. Repeat this routine 10 to 15 times per minute (holding the nostrils).
- (4) Pay attention to the victim to notice if he or she starts to breath. If breathing returns, stop resuscitation.
- (5) If it is impossible to open the victim's mouth, put something like a plastic straw or vinyl tube into one of the nostrils then blow air in while covering the mouth and the other nostril.
- (6) Occasionally, when the victim comes back to consciousness, they immediately try to stand up. Prevent this and keep them in a laying position. Give them something warm to drink and be sure that they rest (do not give them any alcohol).

Administering artificial respiration by raising the head.

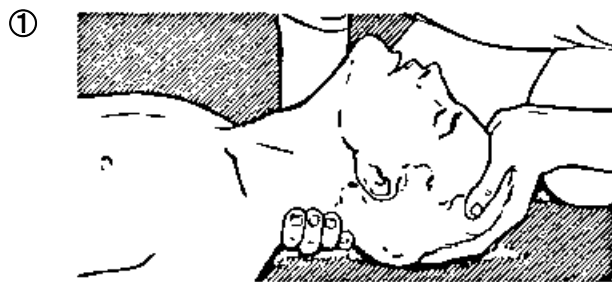

- (1) Raise the back of head, then place one hand on the forehead and place the other hand under the neck. →①
Most victims open their mouth when this is done, making "mouth to mouth" resuscitation easier.

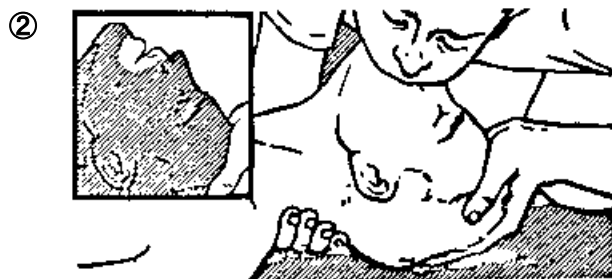

- (2) Cover the victim's mouth by opening your mouth widely, then push your cheek against the victim's nose, →②
or pinch the victim's nose to prevent air from leaking out of it. →③



- (3) Completely exhale into the lungs.
Exhale into the lungs until the chest inflates.
You have to blow as rapidly as possible for the first 10 times.

"Mouth to mouth" artificial respiration
Figure 1

★If the victim has no pulse and is not breathing

(Heart massage in combination with artificial respiration.) Figure 2

If the victim has no pulse, his or her pupils are dilated, and if you cannot detect a heartbeat, the heart may have stopped, beginning artificial respiration is critical.

- (1) Put both hands on the diaphragm, with hands on top of each other keeping both arms straight (If your elbows are bent, you cannot push with as much power). Press the diaphragm with your body weight until the chest sinks about 2 cm (about 50 times per minute).
- (2) If administering first aid when alone:
Perform the heart massage about 15 times then blow in twice. Repeat this routine.
If administering first aid with two people:
One person performs the heart massage 5 times, and the other person blows air in once. Repeat this routine (Heart massage and "mouth to mouth" resuscitation used together).
- (3) Constantly check the pupils and the pulse, if the pupils become normal and the pulse steadies, keep them in a laying position and give them something warm to drink, be sure that they rest (do not give them any alcohol). In any case you have to entrust major decision making to a doctor. Having understanding people around is essential to the victim's recovery from the mental shock of electrocution.

①

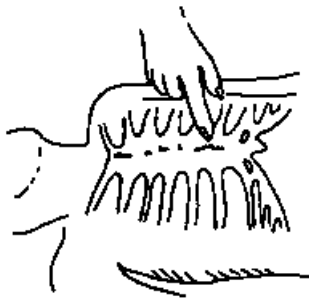

②



③



④

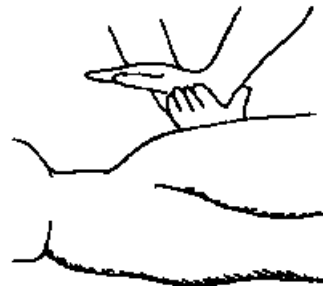

(Heart massage in combination with artificial respiration.) Figure 2

Preface

Thank you for choosing the Model JRC JHS-770S/780D Marine VHF Radiotelephone. This radiotelephone can be used as a Global Maritime Distress and Safety System (GMDSS) radio device, compliant with international regulations, that provides emergency communications and standard communications capabilities for small and large ships.

- Please read this instruction manual thoroughly before using the JHS-770S/780D Marine VHF Radiotelephone, and use it in accordance with the instructions contained herein.
- Please keep this manual available for future reference. Please refer to it if any difficulties are encountered when using the equipment.

FCC Warning

Changes or modifications not expressly approved by JRC, could void your authority to operate this radiotelephone.

Radio Frequency Interference Statement

This radiotelephone has been tested and found to comply with the limits for a Class A digital device, pursuant to part 15 of the FCC Rules. These limits are designed to provide reasonable protection against harmful interference when the equipment is operated in a commercial environment. This radiotelephone generates, uses, and can radiate radio frequency energy and, if not installed and used in accordance with the instruction manual, may cause harmful interference to radio communications. Operation of this radiotelephone in a residential area is likely to cause harmful interference in which case the user will be required to correct the interference at his own expense.



RF exposure compliance (MPE* compliance by FCC)

The antenna used for this transmitter must be installed to provide a separation distance of at least 0.9 meters (3 feet) from all persons and must not be co-located or operating in conjunction with any other antenna or transmitter. Users and installers must be provided with antenna installation instructions and transmitting operating conditions for satisfying RF exposure compliance.

* Maximum Permissible Exposure (MPE): The rms and peak electric and magnetic field strength, their squares, or the plane-wave equivalent power densities associated with these fields to which a person may be exposed without harmful effect and with an acceptable safety factor.

Before Operation

Concerning the symbols

This manual uses the following symbols to explain correct operation and to prevent injury or damage to property.

The symbols and descriptions are as follows. Understand them before proceeding with this manual.



WARNING

Indicates a warning that, if ignored, may result in serious injury or even death.



CAUTION

Indicates a caution that, if ignored, may result in injury or damage to property.

Examples of symbols



The Δ symbol indicates caution (including DANGER and WARNING). The illustration inside the Δ symbol specifies the content of the caution more accurately. (This example warns of possible electrical shock.)



The \ominus symbol indicates that performing an action is prohibited. The illustration inside the \ominus symbol specifies the contents of the prohibited operation. (In this example disassembly is prohibited.)



The \bullet symbol indicates operations that must be performed. The illustration inside the \bullet symbol specifies obligatory instructions. (In this example unplugging is the obligatory instruction.)

Handling precaution



WARNING



Do not open the equipment to inspect or repair it. Inspection or repairs by anyone other than a specialized technician may result in fire, electrical shock, or malfunction. If internal inspection or repair is necessary, contact our service center or agents.



Do not disassemble or customize this unit. Doing so may cause fire, electrical shock, or malfunction.



Do not get this equipment wet or spill any liquids on or near this equipment. Doing so may cause electrical shock or equipment malfunction.



Do not touch any of the areas with warning labels. Doing so may cause electrical shock.



Do not use a voltage other than specified. Doing so may cause fire, electrical shock, or malfunction.



Do not remove protective covers on the high voltage terminals. Doing so may cause electrical shock.



Do not insert anything flammable into the equipment. Doing so may cause fire, electrical shock, or malfunction.



If a distress call is received, make sure to inform the ship's captain or officer in charge. This affects life of the crews and passengers on the ship in distress.



This unit is also used for the distress communication, in addition to usual communication. Contact JRC or our agent if any problem is observed in this unit on usual operation or inspection. Do NOT ignore or leave any problems of this unit.



Always use the specified fuse when replacing a fuse. Using a different fuse may result in fire or malfunction.



Before replacing fuses of the POWER SUPPLY (NBD-865), always turn off the AC/DC power switch and power source output to this unit.



In addition to the AC fuse on the panel of the POWER SUPPLY (NBD-865), there are also DC fuses contained in the unit. Opening and working with the inside of the unit may result in fire or electrocution, so with the exception of qualified service personnel, do NOT attempt to replace the DC fuses. To replace the DC fuses, contact JRC or our agent.

Handling precaution



CAUTION



Do not use this equipment for anything other than specified.
Doing so may cause failure or malfunction.



Do not turn the trimmer resistors or the trimmer capacitors on the PCB unit. Doing so may cause failure or malfunction. They are preset at the factory.



Do not install this equipment in a place near water or in one with excessive humidity, steam, dust or soot. Doing so may cause fire, electric shock, or malfunction.



Do not test the distress call as doing so will inconvenience local shipping and Rescue Centers.



Do NOT turn off the power of the equipment when at sea because the SOLAS Convention requires keeping CH16 watch at all times.



Always listen to CH16 except when talking on a specific channel.



To operate DSC and ATIS functions of this equipment, ID numbers must be registered respectively. If not been registered, contact our agent or service center.



Leave installation of this equipment to our service center or agents. Special knowledge on selecting the place where the antenna is to be mounted and setting the ID number (MMSI) assigned to the ship is required besides mounting operation.



When sending a distress call, follow the instructions of the ship's captain or officer in charge.



If a false distress call (distress alert) is transmitted accidentally, follow the instructions below:

1. Press the **CANCEL** key on the controller (when appropriate, follow the commands on screen) and terminate the transmission of the distress call.
2. Report the false distress call to a nearby RCC (Rescue Coordination Center).
(In Japan, inform the nearest Japan Coast Guard.)

Information to be reported:

The date/time, location, and reason why the false call was transmitted. Also report the ship's name, type, nationality, ID number as well as the unit model name and manufacture number/date, if possible.

3. Report the false distress call to nearby ships using CH16.
4. If any acknowledgements to the distress call are received, inform the ships of the false distress call.



CAUTION



To turn off an alarm or clear a display such as a received DSC message, do NOT press the **DISTRESS** key. Doing so may cause a false distress call.
(Press the **CANCEL** key to turn off the alarm and delete the on screen message.)



When sending a proxy distress call (DROBOSE), do NOT press the **DISTRESS** key. Doing so will inconvenience local shipping and Rescue Centers. (This proxy distress call can be sent via [Call] button displayed on the screen.)



A distress acknowledgement or a distress relay call can be transmitted from a received distress message stored in the log, but when sending such a kind of call, follow the instructions of the ship's captain or officer in charge.



In order to avoid accidental distress message treating, received distress messages will be erased automatically after 48 hours elapsed since the reception. Accordingly, if such messages cannot be read out, it is NOT a malfunction.



The time in the menu 9.1.2 Present time is different from the time in the menu 9.2.2 UTC of position that means the time when the position information is valid.



The time in the menu 9.2.2 UTC of position means the time when the position information is valid, and is different from the present time mentioned above.



Close the water-resistant cap of the waterproof type handset box after use. Rain and sea breeze could cause connector malfunction. Also do not leave the handset above deck.



The thermal head of the printer may be very hot after printing. Do not touch it. Perform paper replacement and head cleaning only after waiting for the head to completely cool.



The printing paper used in this printer is a heat sensitive paper. Take the following precautions when using this paper.

- Store the paper away from heat, humidity, or heat sources.
- Do not rub the paper with any hard objects.
- Do not place the paper near organic solvents.
- Do not allow the paper to come in contact with polyvinyl chloride film, erasers, or adhesive tape for long periods of time.
- Keep away the paper from freshly copied diazo type or wet process copy paper.



For the CHANNEL SELECTOR (NCM-2000) installed above deck, close the water-resistant cap after use. Rain and sea breeze could cause connector malfunction. Also do not leave the handset above deck.

DISTRESS CALLS

Sending a Distress Call (Distress Alert)

CAUTION



When sending a distress call, follow the instructions of the ship's captain or officer in charge.

1. Open the **DISTRESS** key cover on the NCM-1770 CONTROLLER.



2. Press and hold the **DISTRESS** key for 4 seconds. (See the note below.)
When completed the countdown and displayed the screen at right below, the distress call is transmitted.

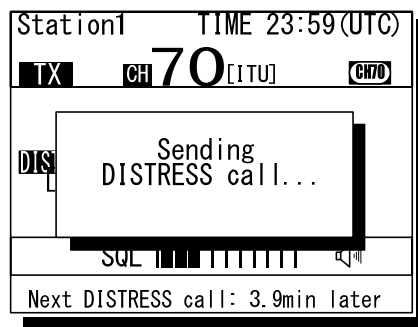
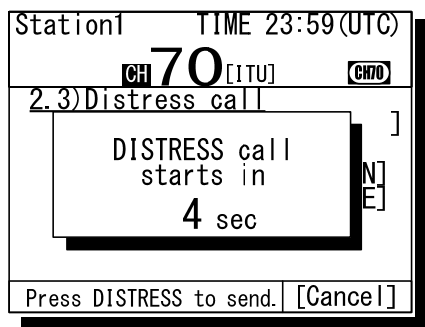

3. After sending the distress call, wait for an acknowledgement.

Radiotelephone can communicate even while waiting for an acknowledgement.

When receiving a distress acknowledgement, the right screen is displayed. Unless received the distress acknowledgement or cancelled the distress call mode manually, this equipment repeats the distress call sending every 3.5 to 4.5 minutes automatically.

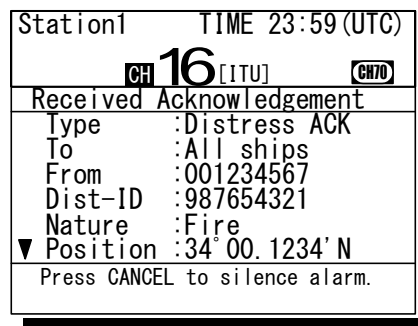

4. After receiving acknowledgement, lift the handset and request rescue using CH16 of the radiotelephone.

First, the responding station calls by radiotelephone. Communicate the following information to that station.

- Say "MAYDAY",
- Say "This is (name of your ship)",
- Tell the ship's Maritime Mobile Service Identity (MMSI) number, call sign, ship's position, nature of distress, and rescue requests

Note

If time permits, enter the nature of the distress call as follows, just before the distress call. (For more details, see 4.4.3.2.)

- 1) Press the **DISTRESS** key momentarily to open the menu 2.3 Distress call.
- 2) Press ENT and select the nature of distress.
- 3) Press ENT to determine the selection.
If not displayed the position and the time (UTC) automatically for any reason, input them manually at this time.
- 4) Press and hold the **DISTRESS** key for 4 seconds to send the distress call.

2.3)Distress call	
Nature	: [Undesignated]
Position:	[NE] [12° 34. 5678' S] [123° 45. 6789' W]
UTC	: [12:20]
Press DISTRESS to send. [Cancel]	

The rest of the procedure is the same as described above.

Terminating Transmission of a Distress Call



CAUTION



If a false distress call is transmitted accidentally, follow the instructions below:

1. Immediately terminate the distress call according to the following procedure.
2. Report the false distress call to a nearby RCC (Rescue Coordination Center).
(In Japan, report to the Japan Coast Guard.)
Information to be reported:
The date/time, location, and reason why the false call was transmitted. Also report the ship's name, type, nationality, ID number as well as the unit model name and manufacture number/date, if possible.
3. Report the false distress call to nearby ships using CH16.
4. If any acknowledgements to the distress call are received, inform the ships of the false distress call.

1. Press the **CANCEL** key.

If the CANCEL key is pressed during transmission of the distress call, immediately returns to the status display.

If the CANCEL key is pressed in the interval between automatic resending of the distress call, the screen as shown below will be displayed. Select Break and press ENT with the jog dial to return to the status display.



Station1	TIME 23:59(UTC)
CH 16 [ITU]	CH70
Now continuing DISTRESS call mode. Break this mode?	
[Continue] [Break]	
SQL []	
Next DISTRESS call: 3.9min later	

Receiving a Distress Call

WARNING



If a distress call is received, make sure to inform the ship's captain or officer in charge. Doing so may save the lives of the crew and passengers on the ship in distress.

1. When a distress call is received, the message will be displayed.

The ALM light will start blinking, and an alarm will sound growing louder gradually.

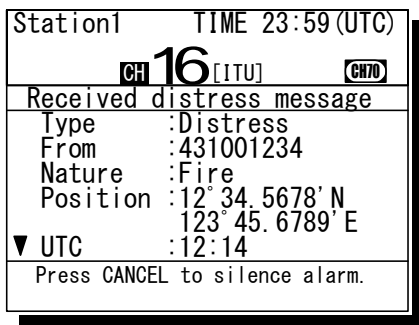

2. Press the **CANCEL** key to stop the alarm, and then press ENT and keep watch on CH16.

Keep watch on CH16 for at least 5 minutes, and notify the coast station as appropriate.

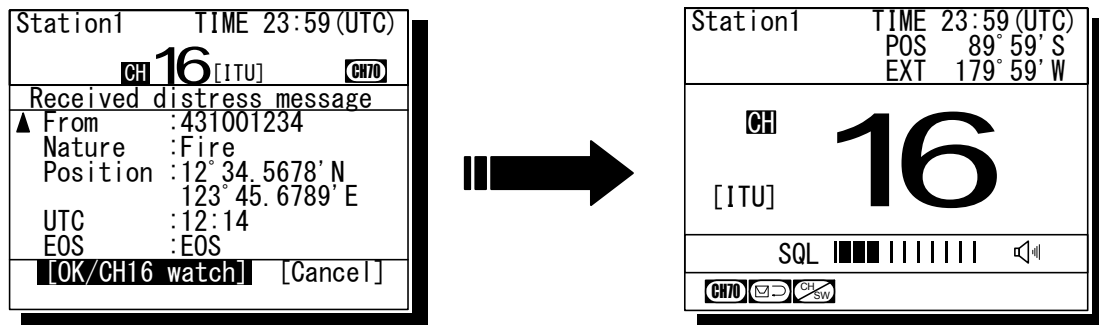

3. When responding due to watching on CH16 and coordinating with the coast station, select the menu of 4.1 Received distress list and send the acknowledgement. After sending it, commence distress traffic via radiotelephony on CH16 as follows.

- Say "MAYDAY",
- Repeat the identity (MMSI) of the ship in distress 3 times,
- Say "This is",
- Repeat the identity (MMSI) of your ship 3 times,
- Say "RECEIVED MAYDAY".

Equipment exterior

- JHS-770S/780D VHF Marine Radiotelephone



NTE-770S/780D VHF Transceiver

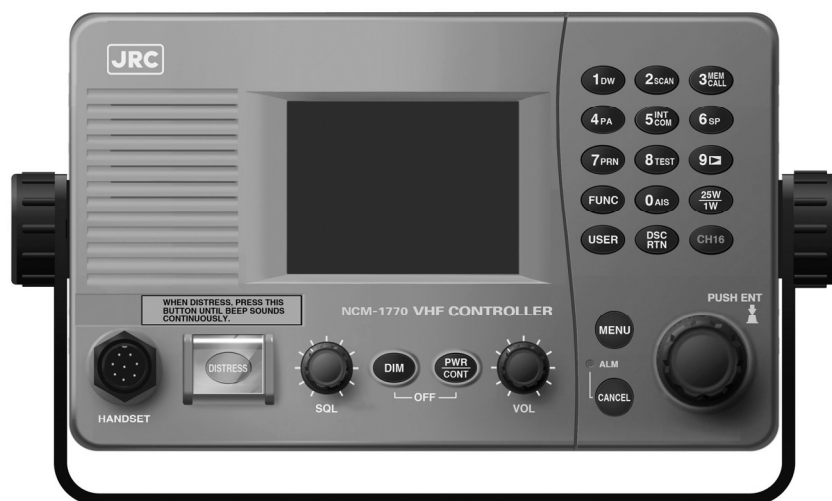

NCM-1770 VHF Controller / NQW-261 Handset

- NQE-1845 Handset Connector Box
Waterproofed flush mount type
(for wing console)



- NQE-1846 Handset Connector Box
Waterproofed wing installation type

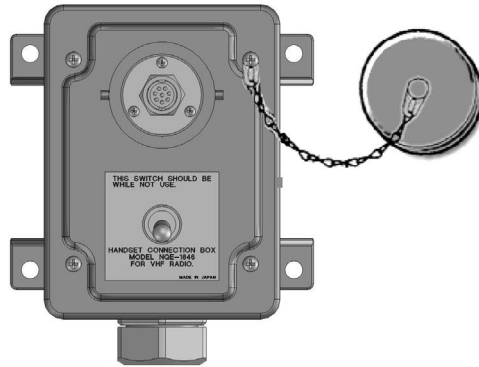

- NQE-1847 Handset Connector Box
Indoor flush mount type



- NCM-2000 VHF Channel Selector



- NBD-865 AC/DC Power Unit



- NCH-321A Distress Message Controller

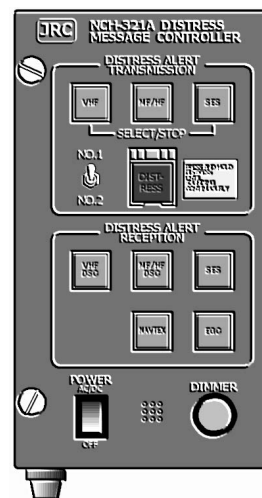

- NKG-91 Printer

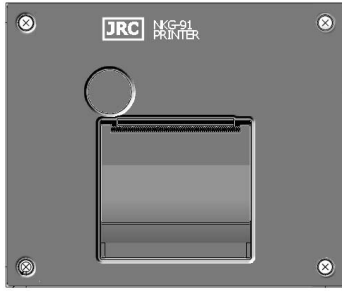

- DPU-414 Printer



- NVS-423R External Speaker

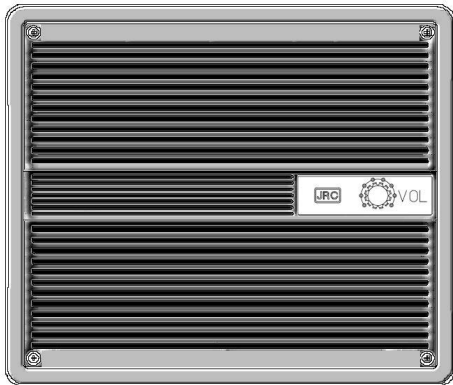

Contents

Preface	i
Before operation	ii
Handling precaution	iii
DISTRESS CALL	vi
Equipment exterior	ix
Glossary of terms	xvi
1 EQUIPMENT OVERVIEW	1-1
1.1 Functions	1-1
1.2 Features	1-1
1.3 Basic configuration	1-2
1.3.1 Basic configuration of the main unit	1-2
1.3.2 Options	1-2
1.3.3 System configuration	1-3
1.4 External dimensions	1-4
1.5 Block diagram	1-13
2 NAMES AND FUNCTIONS	2-1
2.1 Controller (NCM-1770)	2-1
2.2 Main displays	2-3
2.2.1 Status display	2-3
2.2.2 Menu screen	2-4
2.2.3 DSC message receiving screen	2-5
3 INSTALLATION	3-1
4 OPERATION	4-1
4.1 Controller operation overview	4-1
4.2 Basic communication procedure	4-3
4.2.1 Turning ON the power	4-3
4.2.2 Turning OFF the power	4-4
4.2.3 Communicating with the radiotelephone	4-5
4.2.4 Receiving with scanning	4-7
4.2.5 Receiving with dual watch	4-8
4.2.6 Using memory channels	4-9
4.2.7 Communicating on a private channel	4-11
4.2.8 Receiving a weather channel	4-11
4.2.9 Changing the channel region	4-12

4.2.10 Squelch settings of each channel (preset squelch)	4-13
4.3 Basic DSC operations	4-14
4.3.1 Routine calls to a coast station	4-14
4.3.2 Routine calls to a ship station	4-16
4.3.3 Receiving a routine call	4-17
4.3.4 Communicating with a PSTN subscriber	4-20
4.3.5 AIS-linked DSC calls	4-23
4.4 Emergency calls (DSC Safety/ Urgency/ Distress Calls)	4-25
4.4.1 Safety calls	4-25
4.4.1.1 All ships calls	4-25
4.4.1.2 Individual calls (All modes RT)	4-26
4.4.1.3 Other features of the safety call (Position request/ Test)	4-28
4.4.1.4 Receiving a safety call	4-30
4.4.2 Urgency calls	4-32
4.4.2.1 All ships calls	4-32
4.4.2.2 Individual calls	4-33
4.4.2.3 Special calls (Medical transport/ Neutral ship)	4-35
4.4.2.4 Receiving an urgency call	4-36
4.4.3 Distress calls (Distress alerts)	4-38
4.4.3.1 Quick distress calls	4-38
4.4.3.2 Distress calls from the menu	4-40
4.4.3.3 Receiving a distress call	4-42
4.4.3.4 Acknowledgement to a received distress call	4-43
4.4.4 Distress relay calls on behalf of someone else (Proxy distress calls)	4-44
4.4.4.1 All ships calls	4-44
4.4.4.2 Coast station calls	4-46
4.4.4.3 Receiving a proxy distress call	4-49
4.4.5 Distress relay calls	4-50
4.4.5.1 Sending a distress relay call	4-50
4.4.5.2 Receiving a distress relay call	4-52
4.5 Simple DSC test call	4-54
4.6 DSC call log	4-55
4.6.1 Received distress messages	4-55
4.6.2 Received other messages	4-56
4.6.3 Transmitted messages	4-57
4.7 Other features	4-58
4.7.1 Notification of registered ships by the AIS	4-58
4.7.2 Playback of received voice	4-59
4.7.3 Public Address function with an external speaker (option)	4-62
4.7.4 Intercom	4-63
4.8 Popup screens	4-65

5	SETTINGS & REGISTRATIONS	5-1
5.1	Date and time setting	5-1
5.2	Own ship position and time setting	5-3
5.3	Settings for each controller	5-4
5.3.1	LCD adjustment	5-4
5.3.2	Sound settings	5-4
5.3.3	User key assignment	5-5
5.3.4	Name a controller	5-6
5.3.5	Disabling the hook switch	5-7
5.4	Creating contact lists	5-8
5.5	Advanced settings for DSC	5-11
5.5.1	Automatic acknowledgement	5-11
5.5.2	Disabling the automatic channel shift	5-11
5.5.3	Disabling receiving alarms for routine and safety calls	5-12
5.5.4	Medical/Neutral use setting for urgency calls	5-12
5.5.5	Expanded MMSI registration	5-12
5.6	Other settings	5-13
5.6.1	Enabling the AIS function	5-13
5.6.2	Printer property	5-14
6	MAINTENANCE & INSPECTION	6-1
6.1	General maintenance & inspection	6-1
6.2	Self diagnosis inspection	6-2
6.3	System alarm indication	6-4
6.3.1	Alarm list	6-5
6.3.2	Viewing the alarm history	6-6
6.4	Checking the setup condition	6-7
6.4.1	System information	6-7
6.4.2	Software version	6-7
6.5	DSC AF inspection	6-8
6.6	Troubleshooting	6-9
6.6.1	Procedures for locating malfunctions	6-9
6.6.2	Guide to locating faults	6-10
6.6.3	Repair units/parts	6-11
6.6.4	Regular replacement parts	6-11
7	AFTER-SALES SERVICE	7-1
8	DISPOSAL	8-1
9	SPECIFICATIONS	9-1
9.1	JHS-770S/780D Marine VHF Radiotelephone	9-1
9.2	Channel assignment tables	9-4
9.3	Options	9-9

9.4 Peripheral interfaces	9-10
---------------------------------	------

10 OPTIONS OPERATION 10-1

10.1 Handset connection box (NQE-1845/ 1846/ 1847)	10-1
10.2 AC/DC Power supply (NBD-865)	10-2
10.3 Printer (NKG-91)	10-3
10.4 VHF Channel selector (NCM-2000)	10-4

Appendix) Declaration on toxic & hazardous substances or elements (1/1)

Glossary of terms

This section contains general and DSC terms related to this equipment.

● General terms

AIS (Automatic Identification System)

Equipment that transmits a ship's Maritime Mobile Service Identity number, ship name, ship position, speed, orientation, and other information to and from other ships. AIS equipment is required on some ships by the International Convention for the Safety of Life at Sea (SOLAS)

ATIS (Automatic Transmitter Identification System)

This is used for notification of the radio station ID to receivers when using European inland waterway (IWW) channels.

CCG (Canadian Coast Guard)

Canadian Coast Guard

DSC (Digital Selective Calling)

Used in routine calls, safety and urgency calls, and distress calls for rescue request.

GMDSS (Global Maritime Distress and Safety System)

Global Maritime Distress and Safety System

GPS (Global Positioning System)

Global Positioning System

IMO (International Maritime Organization)

International Maritime Organization

Intercom

Wired communications equipment or functionality

ITU (International Telecommunication Union)

The leading United Nations agency for information and communication technologies. Establishes conventions and regulations for all electrical communications. It contains internal organizations such as ITU-R and ITU-T.

ITU-R

The International Telecommunication Union (ITU) radio communications department

IWW (Inland Waterway)

Inland Waterway

LT (Local Time)

Local Time

MMSI (Maritime Mobile Service Identity)

The 9-digit Maritime Mobile Service Identity

number assigned to each ship and coast station.

NMEA (National Marine Electronics Association)

Maritime equipment transmission standard established by the National Marine Electronics Association

NNSS (Navy Navigation Satellite System)

Doppler based satellite positioning system operated by the United States Navy.

PA (Public Address)

Sound amplification equipment

In this radiotelephone equipment, it is a function for using an external public address.

PTT (Push To Talk)

Handset button pressed to talk

RCC (Rescue Co-ordinate Center)

In Japan, the Japan Coast Guard.

RMS (Remote Maintenance System)

Transmits ship equipment information temporarily stored in VDR via Inmarsat to land, for use in maintenance and management of radio equipment.

RR (Radio Regulations)

Intergovernmental treaty text of the ITU

SAR Convention (International Convention on Maritime Search and Rescue)

International Convention on Maritime Search and Rescue

SOLAS Convention (International Convention for Safety of Life at Sea)

The international convention applied to all ships engaged on international voyages. A safety certificate is issued if the conditions of this convention are satisfied.

SQL (Squelch)

A function that acts to suppress the audio output of a receiver in the absence of a sufficient radio strength signal.

Station

A radio station, or a control terminal for radio equipment

USCG (United States Coast Guard)

United States Coast Guard

UTC (Universal Time Coordinated)

Universal Time Coordinated

VDR (Voyage Data Recorder)

After a maritime accident, recovered to analyze the recorded data (speed, rudder, bridge conversation, VHF audio, etc.) to determine the cause of the accident.

It can also transmit navigation management data regularly via Inmarsat to land.

VHF (Very High Frequency)

Very High Frequency (30 - 300MHz)

VOL (Volume)

Internal speaker volume

WRC (World Radiocommunication Conference)

World Radiocommunication Conference

WMO (World Meteorological Organization)

World Meteorological Organization

WKR (Watch Keeping Receiver)

Dedicated receiver for CH70 to watch the DSC signals.

● DSC terms**Address**

General term for Maritime Mobile Service Identity number (MMSI)

This equipment uses To/From to distinguish between the sender and receiver. It also means the Self-ID (own ship MMSI) and Dist-ID (MMSI of a ship in distress).

Category

Message code indicating priority of the call.

It contains types as below.

- RoutineGeneral calls for routine works
- SafetySafety communications call
- UrgencyUrgent communications call
- Distress.....Distress call (Distress alert)

EOS (End Of Sequence)

Termination code appended to the call messages.

It contains types as below.

- EOS.....End of sequence
- ACK RQ.....Acknowledgement request
- ACK BQ.....Acknowledgement responding to the ACK RQ

ECC (Error Check Character)

Error check code appended to the end of call messages.

This is not normally displayed, but if an error occurs, one of the following will be displayed.

- ECC errorMessage error
- Ex ECC error....Expansion message error

Format

Message code indicating type of call.

It contains types as below.

- Individual callIndividual call

- Individual ACKAcknowledgement response to individual call
- Individual NACKNegative acknowledgement response to individual call
- Semi/auto call.....PSTN connection call
- Semi/auto ACK.....PSTN call acknowledgement
- Semi/auto NACK ...PSTN call negative acknowledgement
- Group callCall to ships having common interest
- All ships call.....Call to all ships
- DistressDistress call

Nature of Distress

Message code indicating type of distress when a distress call is issued.

It contains types as below.

- FireFire, explosion
- FloodingFlooding
- Collision.....Collision
- Grounding.....Grounding
- ListingRisk of ship capsizing
- SinkingSinking
- DisabledShip inoperable/adrift
- UndesignatedUndesignated distress
- AbandoningAbandoning ship
- Piracy attack.....Piracy attack
- Man overboardMan overboard
- EPIRB emissionDSC VHF EPIRB reception

Polling

Polling is a feature for routine calling.

It is used, for example, to confirm whether a ship is existing within radio range when a coast station requests navigational information to the ship.

PSTN (Public Switched Telephone Network)

General fixed landline telephone network.

Reason

Message code indicating reason for negative acknowledgement response.

- No reason No reason
- Congestion..... Maritime information exchange center congested
- Busy..... Busy
- Queue Queued
- Barred Station barred
- No operator..... No operator
- Temp no oper Temporarily no operator
- EQP disabled Equipment disabled
- Unable channel..... Indicated channel cannot be used
- Unable mode..... Indicated mode cannot be used

Subject

Message code clarifying communication contents when sending an urgency call to all ships.

When sailing dangerous waters, such as political instability, these call messages with the following information are used.

- Neutral ship..... In accordance with ITU resolution 18 (Mob-83), inform all ships that own ship is of neutral nationality.
- Medical TRNSP Inform all ships that own ship is performing medical transportation, and is protected under the 1949

Geneva Convention.

Type

Main contents of call message.

Normally, the 1st telecommand will be indicated, but for a distress related call, it may also take into account the Format and the EOS. Displayed when message is received, as well as in LOG.

- All modes RTAll F3E/G3E radiotelephones
- Duplex RT.....Duplex F3E/G3E radiotelephones
- Polling.....Polling
- DataData transmission
- Position RQShip position request
- Ship positionShip position notification
- Test.....Safety test call
- Unable to complyNegative acknowledgement
- Distress.....Distress call message
- Distress ACKAcknowledgement of distress call message
- Distress relay.....Distress relay message
- Dist-relay ACKAcknowledgement of distress relay message
- Proxy distressDistress relay message on behalf of someone else
- Proxy dist-ACKAcknowledgement of distress relay call on behalf of someone else

Work CH

Message code indicating a work channel to communicate using radiotelephone.

1. EQUIPMENT OVERVIEW

1.1 Functions

This equipment includes VHF radiotelephone, Class-A DSC and DSC watchkeeping receiver required as the Global Maritime Distress and Safety System (GMDSS). It is designed as a separated transceiver and small, lightweight controller(s) for easy installation not only in international passenger ships and freight ships of 300 tons or more, but also conventional ships of less than 300 tons.

It has the radiotelephone, the DSC communication functions, received voice recording and playback function, and self-diagnosis function with simple operation using a dedicated key. Additionally, it offers such as public address function using an external speaker, intercom function for communication between controllers, and the DSC calling function using an automatic identification system (AIS) information.

1.2 Features

- Compliant with the ITU Radio Regulations (RR), the IMO performance standards, and the ITU-R recommendations.
- Contains all channels specified in the ITU Radio Regulations (RR).
- In addition to channels specified in the ITU Radio Regulations (RR), this equipment also provides USA, Canada, European inland waterway, and weather channels. It also allows the use of up to 200 private channels.
- Contains ATIS (Automatic Transmitter Identification System) function for the inland waterway channels.
- Separately designed transceiver and controller enable easy installation in limited or difficult spaces.
- A semi-transmissive LCD with a wide viewing angle features easily viewable even when with straight light or backlit and allows it to install variety positions.
- The backlights of the LCD and operation keys are fully adjustable, preventing interference with night watch keeping.
- The DSC is very easy to operate, especially a routine call, which can be sent by pressing the dedicated routine call key and selecting address only. Additionally prepared a dedicated menu for DSC safety test calling to make a radio communication inspection simple.
- When in distress, the DSC can send the distress message with the expanded position data containing the digits up to 1/10000 of minutes for both latitude and longitude to make search and rescue operation by the RCC easier.
- The received voice recording and playback function enables later confirmation or temporary saving of communications.
- An advanced digital audio amplifier with a built-in loud speaker provides $5W_{\max}$ of clear audio.
- A dedicated self-diagnosis key makes maintenance and inspection simple.
- Besides printers and GPS, other peripherals such as the AIS, the VDR, and/or remote maintenance systems (RMS) can be connected to this equipment.

1.3 Basic configuration

1.3.1 Basic configuration of the main unit

No.	Product Name	Model Name	Qty	Notes
1	VHF Transceiver	NTE-770S, or NTE-780D	1	NTE-770S: JHS-770S, Simplex NTE-780D : JHS-780D, Duplex
2	VHF Controller	NCM-1770	1	Includes the connection cable (7ZCJD0299A)
3	Handset	NQW-261	1	Includes the cradle
4	Instruction Manual	7ZPJD0406A	1	This manual

1.3.2 Options

No.	Product Name	Model Name	Notes
1	TRX Antenna	7ABJD0004	1.29m Dipole type
2	WKR Antenna	7ABJD0004	1.29m Dipole type
3	Antenna mounting bracket	MPBX41928A	Used for each antenna
4	Coaxial connector	N-P-10U	
5	AC/DC Power supply	NBD-865	
6	VHF Controller	NCM-1770	Up to 2 additional controllers available.
6-1	Flush mounting bracket	MPBC42957	
6-2	Mounting bracket	MPBX44354	
7	VHF Channel selector	NCM-2000	Waterproof type (IP66 equivalent)
7-1	Connection box	NQE-7720	For stand-alone installation above deck
8	Connection box	NQD-2770	For connecting additional controllers or channel selectors
9	Handset	NQW-261	Waterproof type (IP66 equivalent) For controllers and channel selectors
10	Handset connection box	NQE-1845	Wing console/ flush mount type (IP66 equivalent)
11	Handset connection box	NQE-1846	Wing installation type (IP66 equivalent)
12	Handset connection box	NQE-1847	Indoor flush mount type
13	Printer	NKG-91	Wall mount or flush mount type
13-1	Printer connection cable	7ZCJD0254A	
13-2	Printer paper	7ZPJD0384	
13-3	Wall mounting bracket	MPBP31446	
14	Printer	DPU-414	Desktop type
14-1	Printer connection cable	7ZCJD0254A	
14-2	Printer power cable	7ZCJD0257C	
14-3	Printer paper	6ZCAF00252A	
15	Extension board	CQD-7701	For optional peripherals
16	External speaker	NVS-423R	Wall mount type
17	Distress message controller	NCH-321A	

1.3.3 System configuration

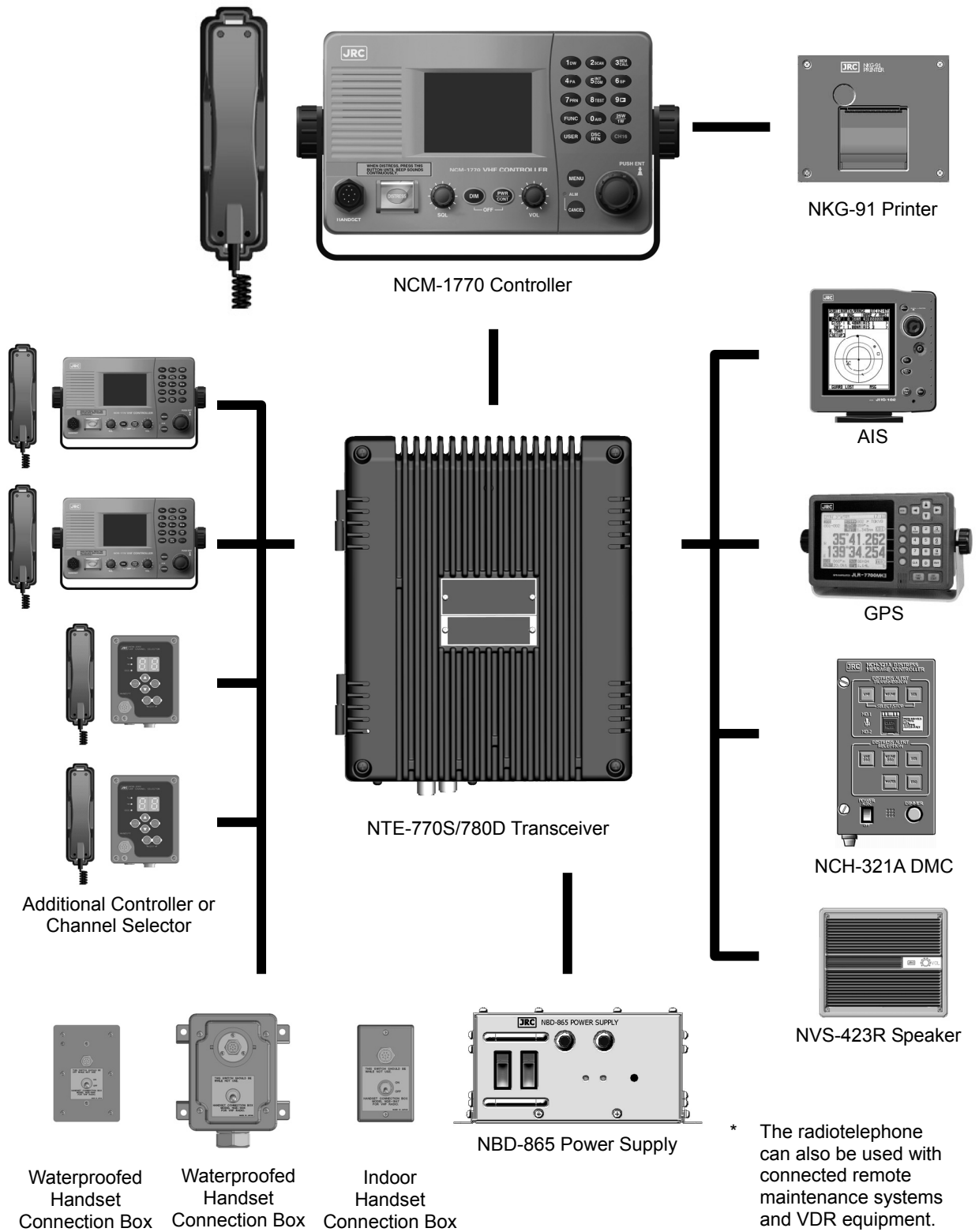

1.4 External dimensions

Below are the external dimensions of each unit.

(1) VHF Transceiver (NTE-770S/780D)

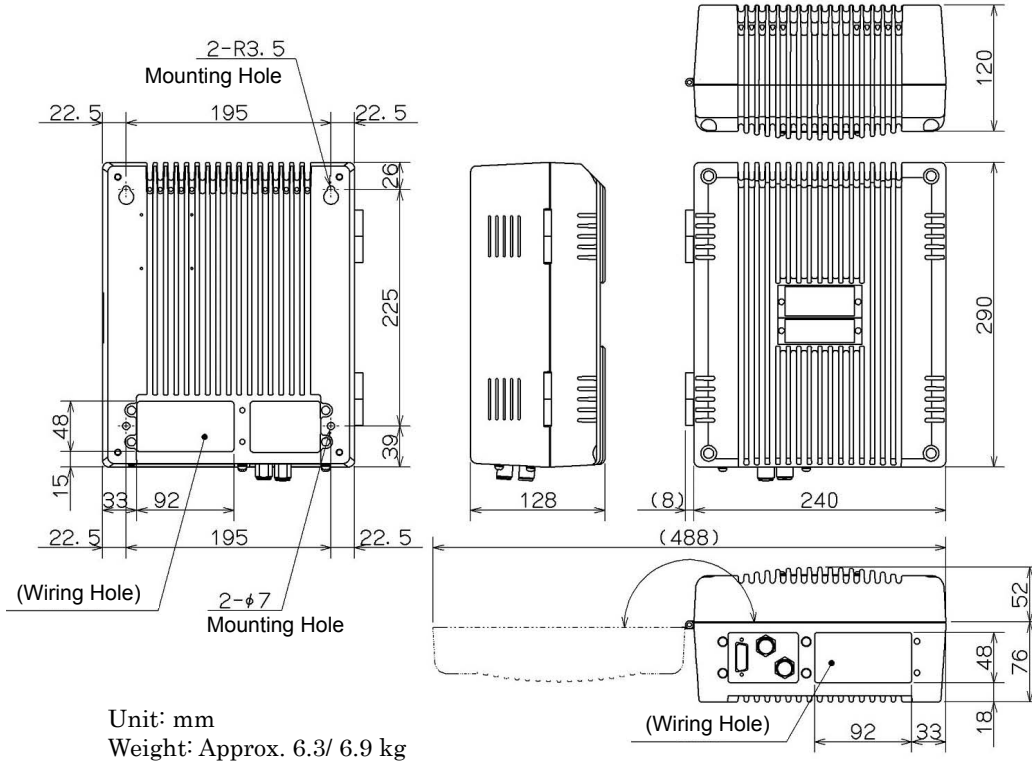

(2) VHF Controller (NCM-1770)

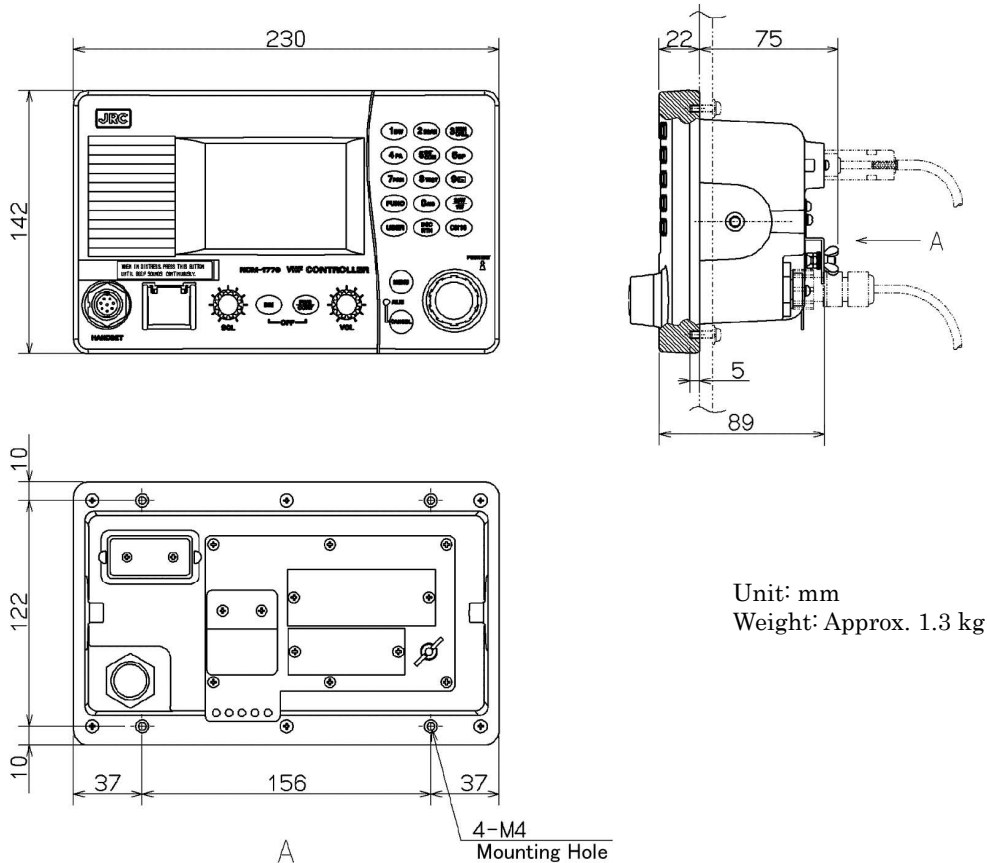

(3) Handset (NQW-261)

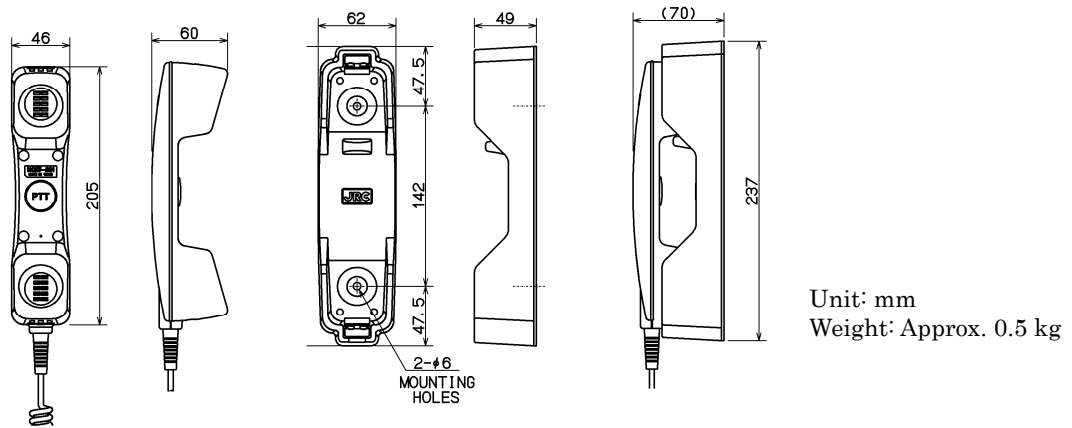

(4) Antenna (7ABJD0004) and Mounting bracket (MPBX41928A)

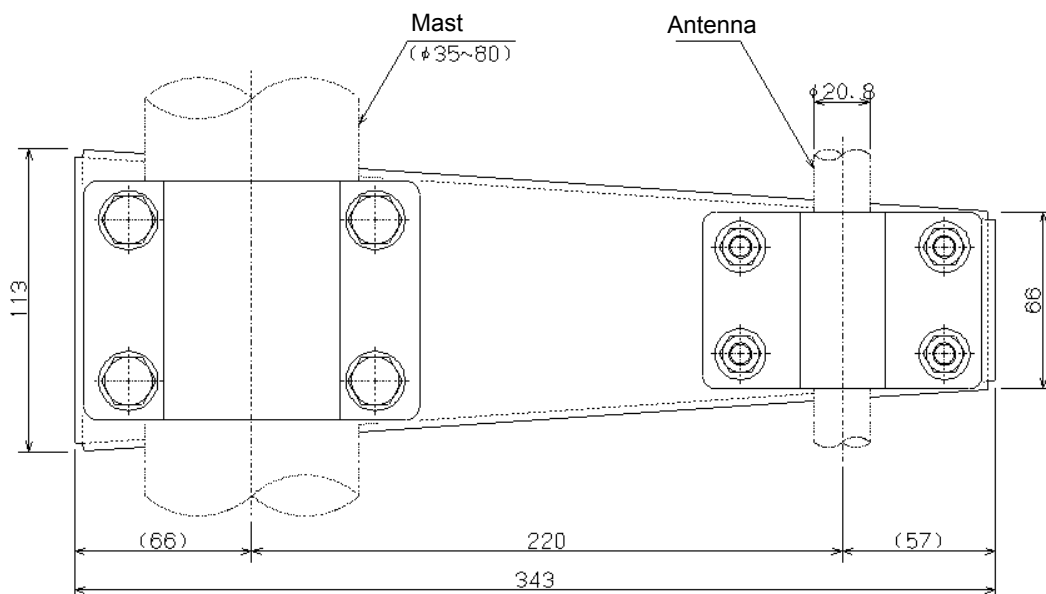
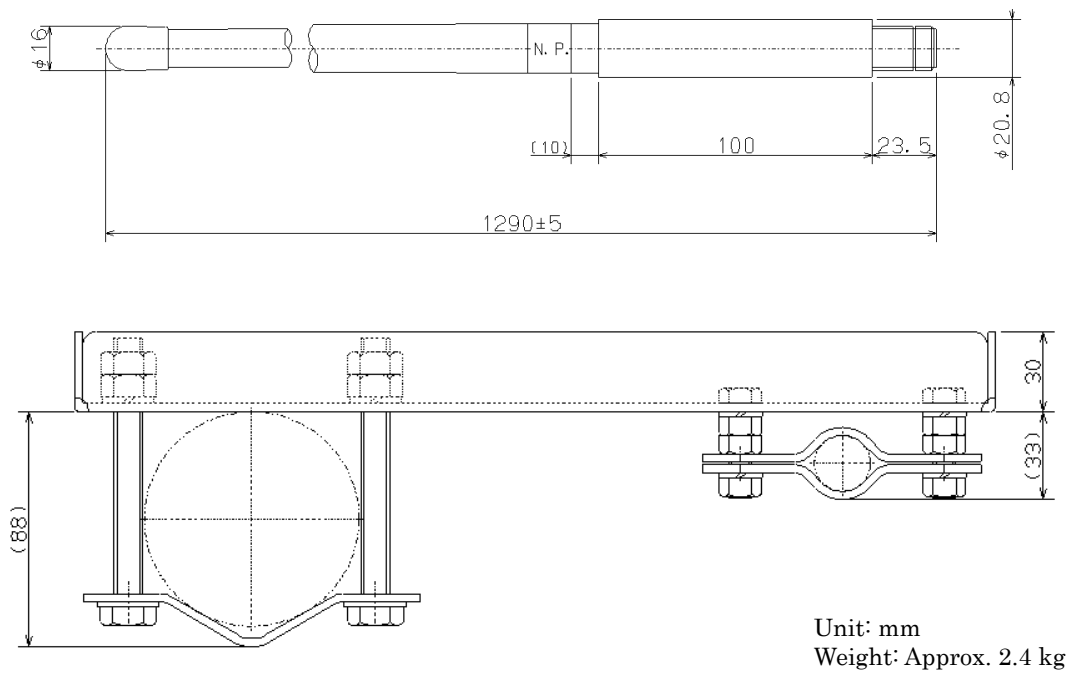

(5) AC/DC Power supply (NBD-865)

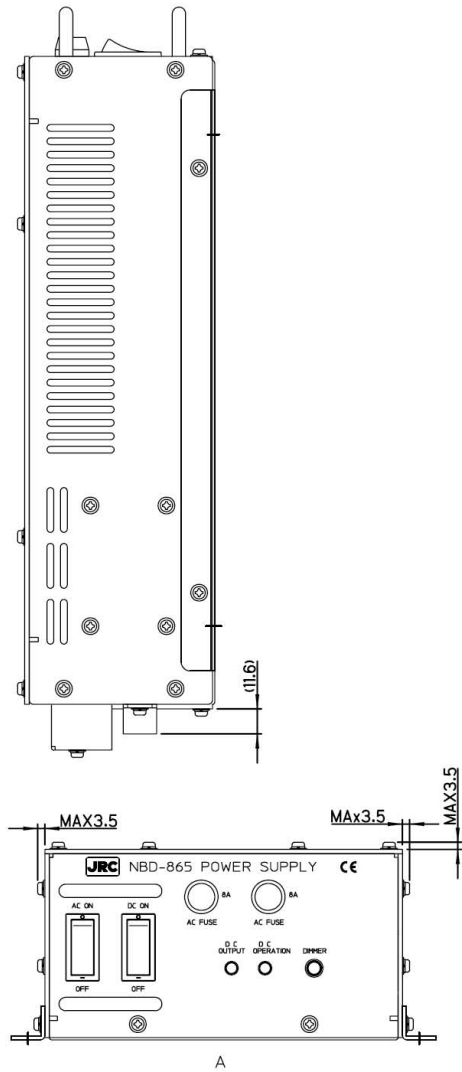
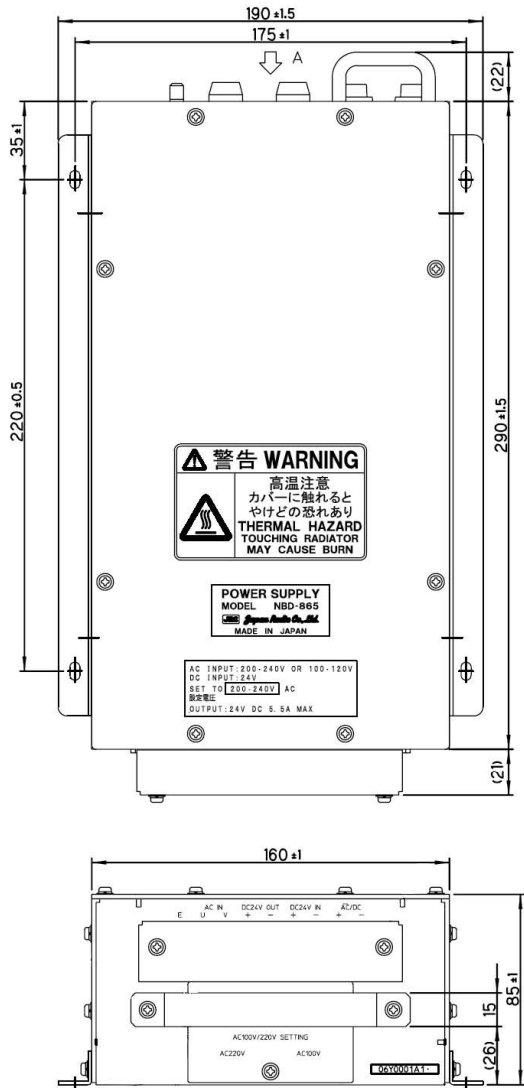

Unit: mm
Weight: Approx. 6.1 kg

(6) VHF Channel selector (NCM-2000)

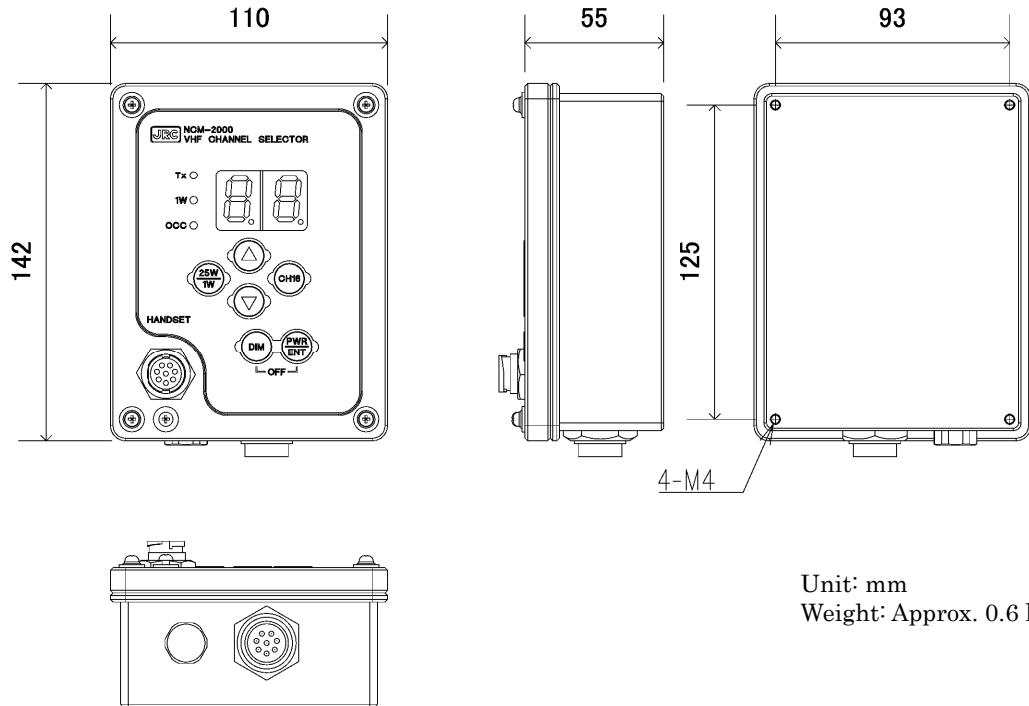

Unit: mm
Weight: Approx. 0.6 kg

(7) Controller connection box (NQD-2770)

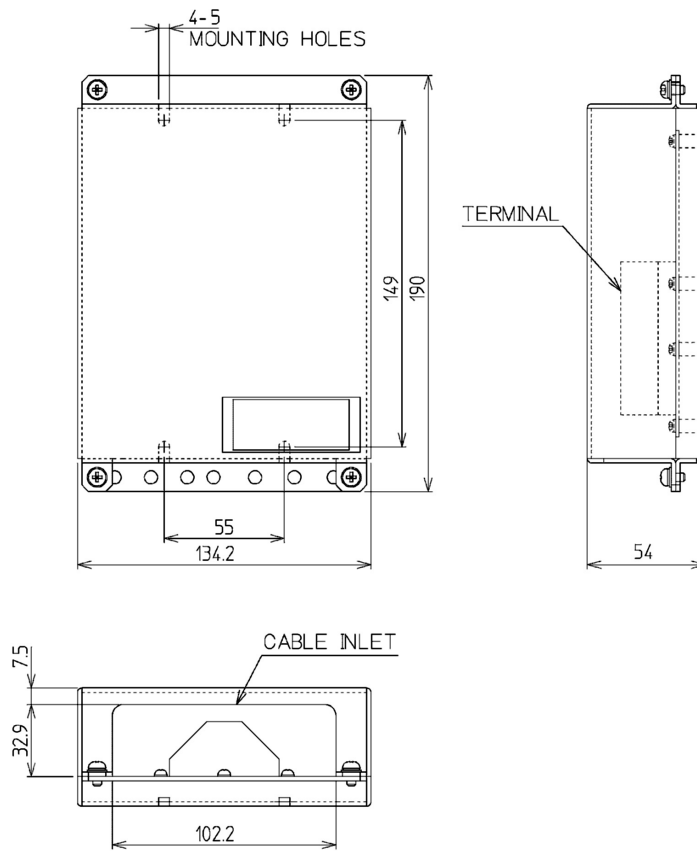

Unit: mm
Weight: Approx. 0.6 kg

(8) Handset connection box (NQE-1845)

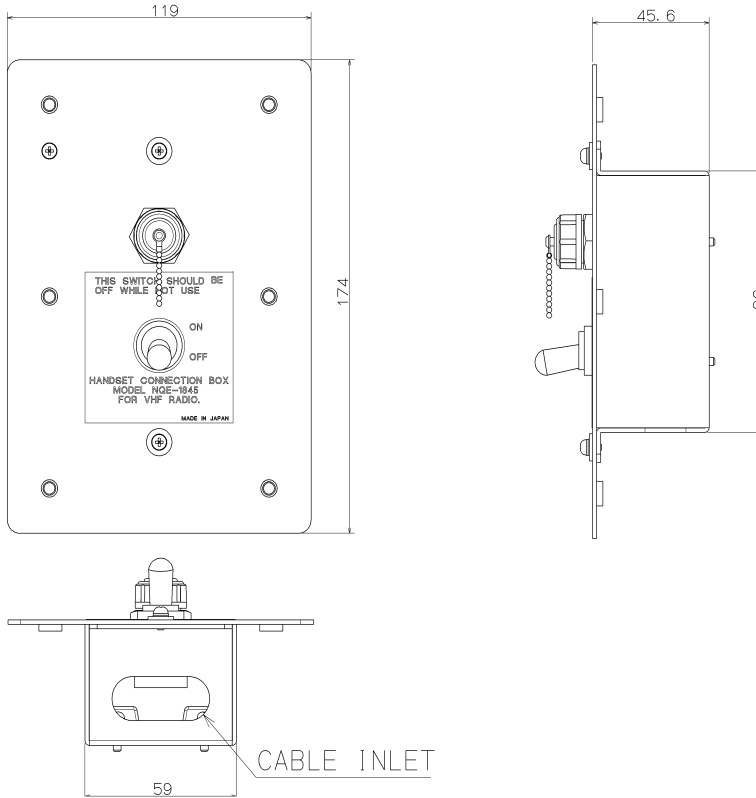

Unit: mm
Weight: Approx. 0.5 kg

(9) Handset connection box (NQE-1846)

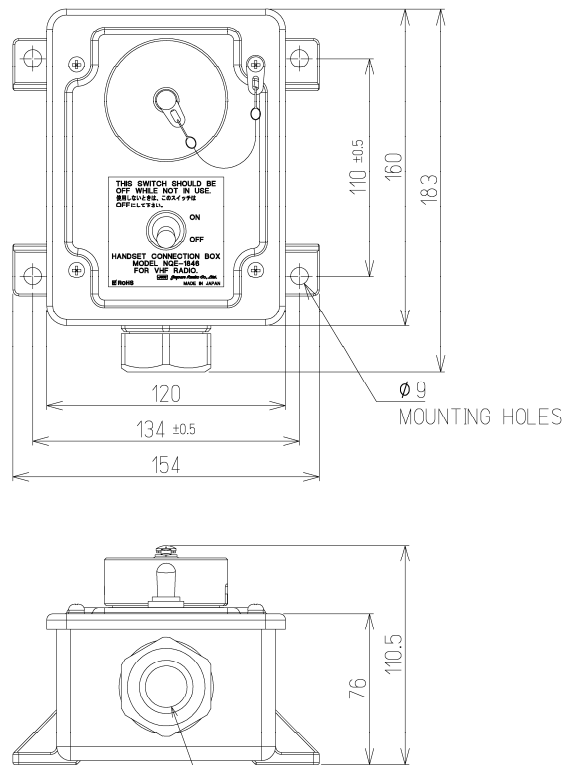

Select the size the number bushing suitable for the cables as follows.

-20a attachment
-25a attachment
-30a standard composition

Unit: mm
Weight: Approx. 1.1 kg

(10) Handset connection box (NQE-1847)

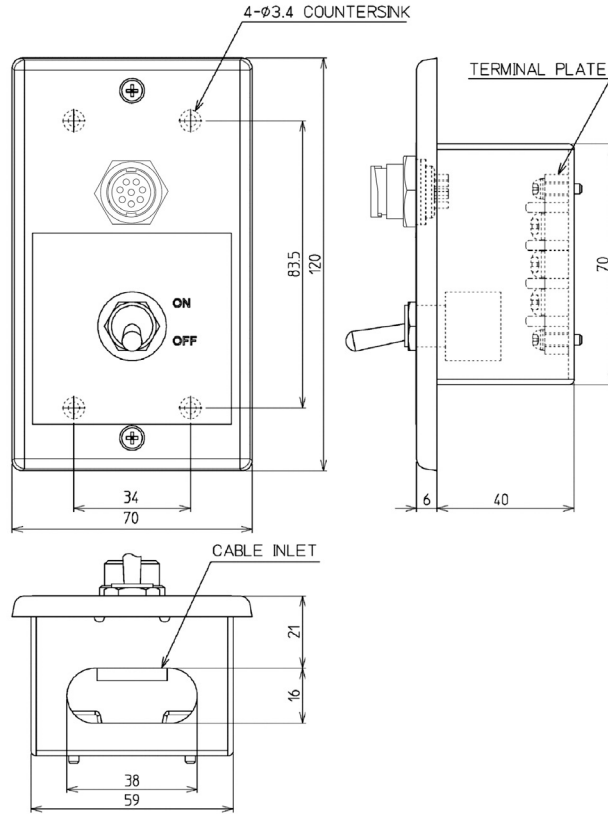

Unit: mm
Weight: Approx. 0.3 kg

(11) Printer (NKG-91)

- Wall mount type

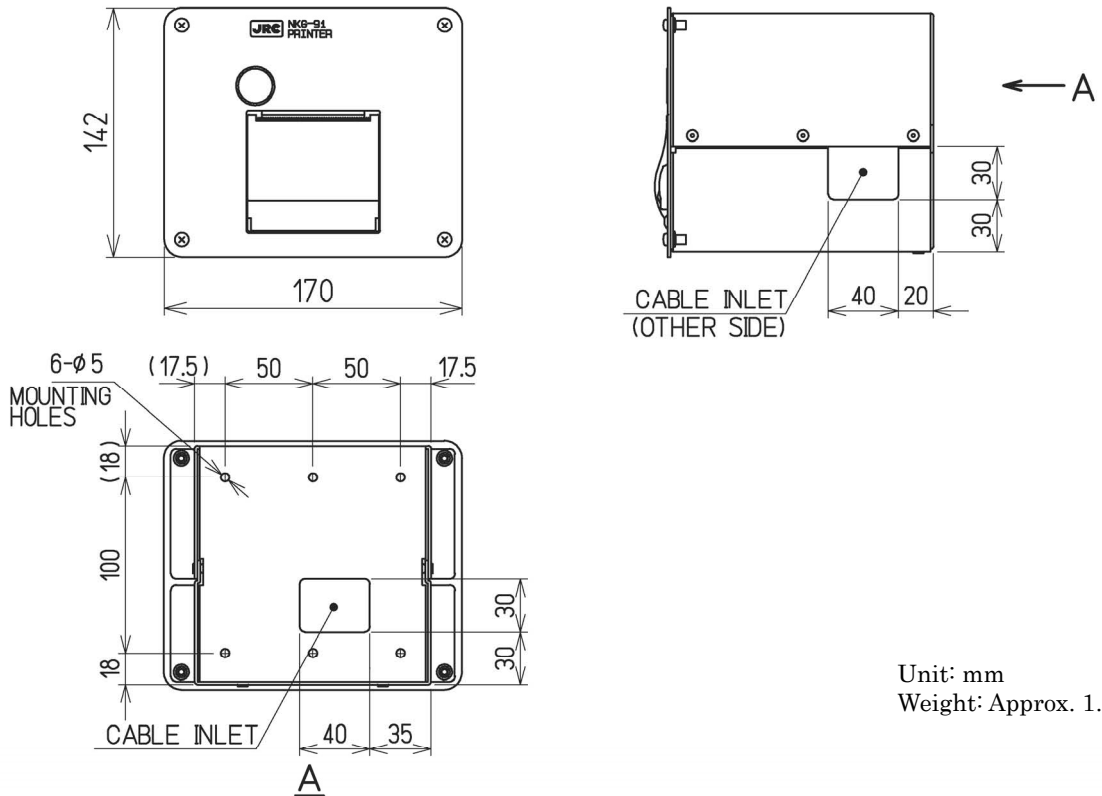

Unit: mm
Weight: Approx. 1.5 kg

Equipment Overview

● Flush mount type

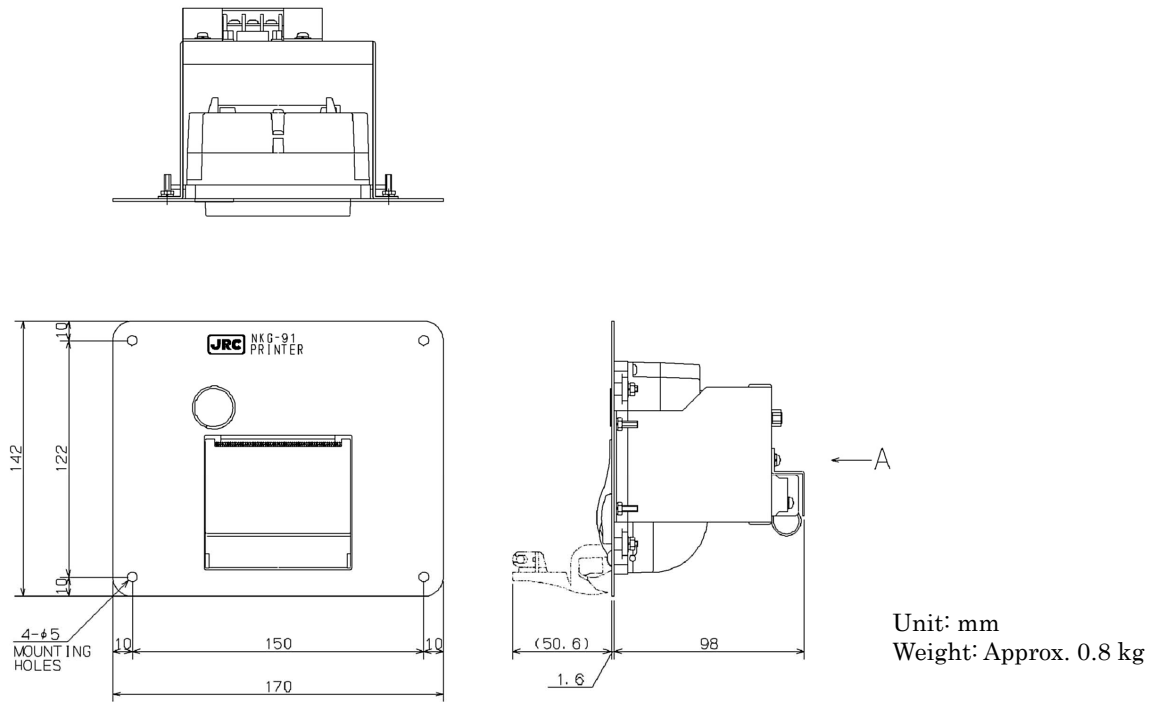

(12) Printer (DPU-414)

● Desktop type

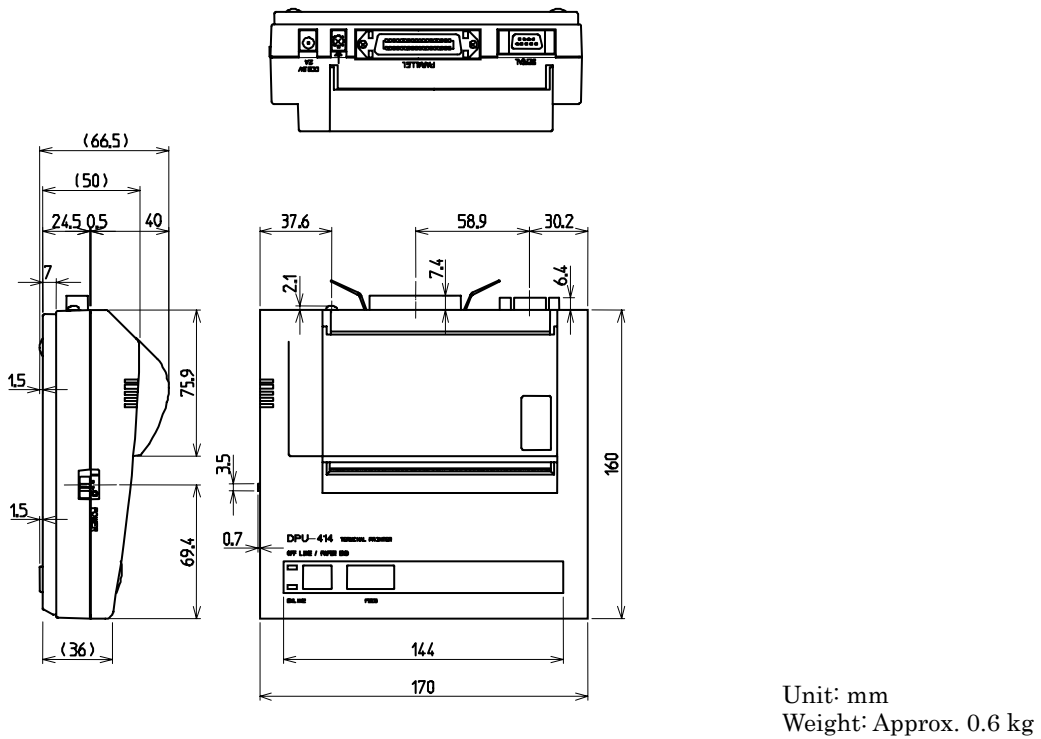

(13) External speaker (NVS-423R)

- Wall mount type

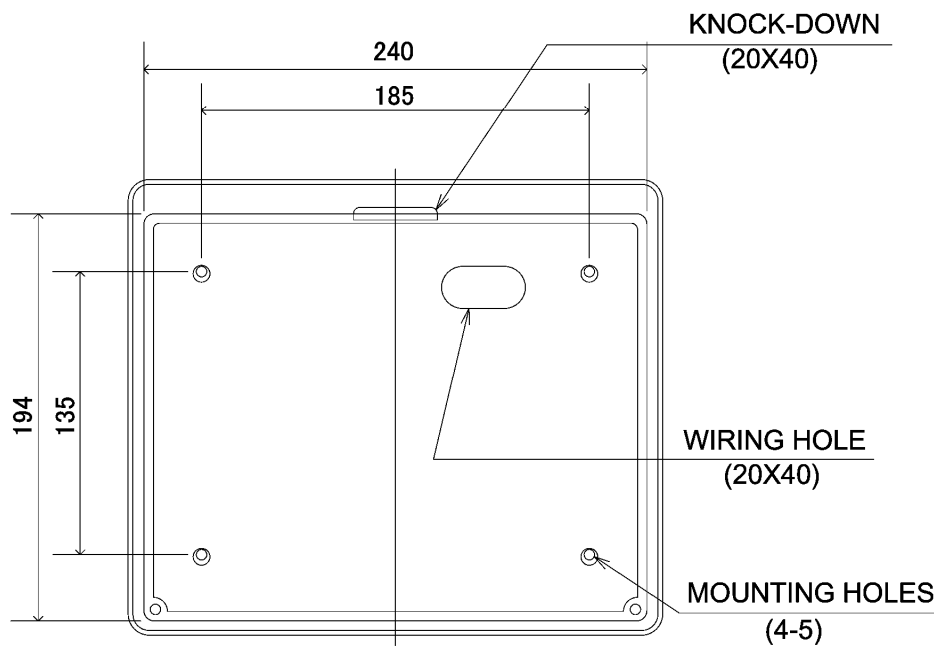
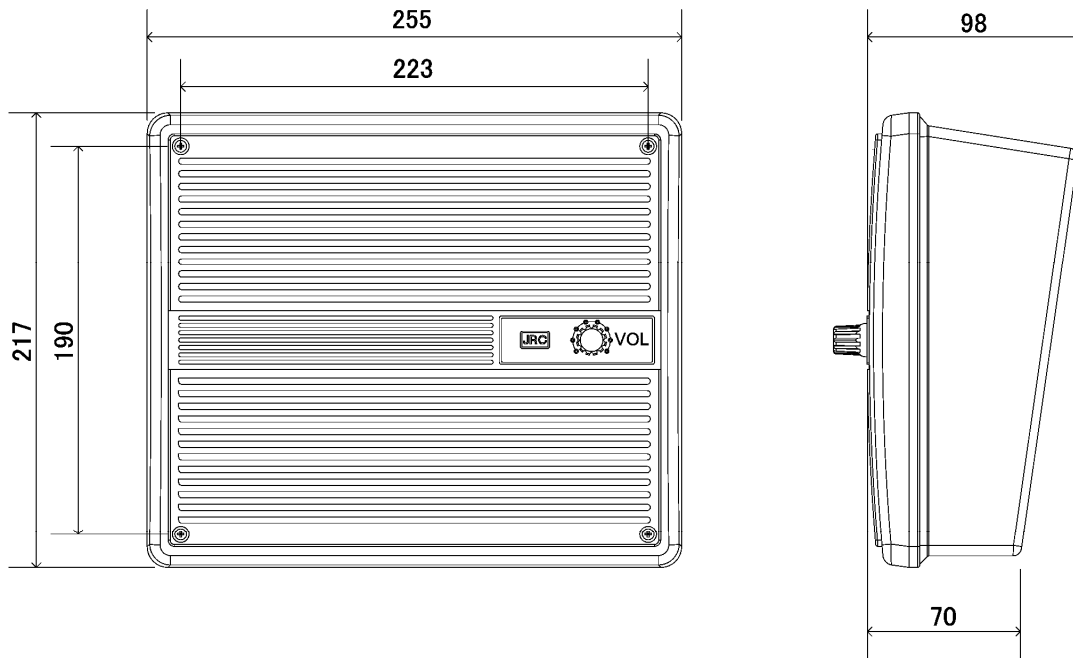

Unit: mm
Weight: Approx. 1.1 kg

(14) Integrated console (JHS-770S-CON/JHS-780D-CON)

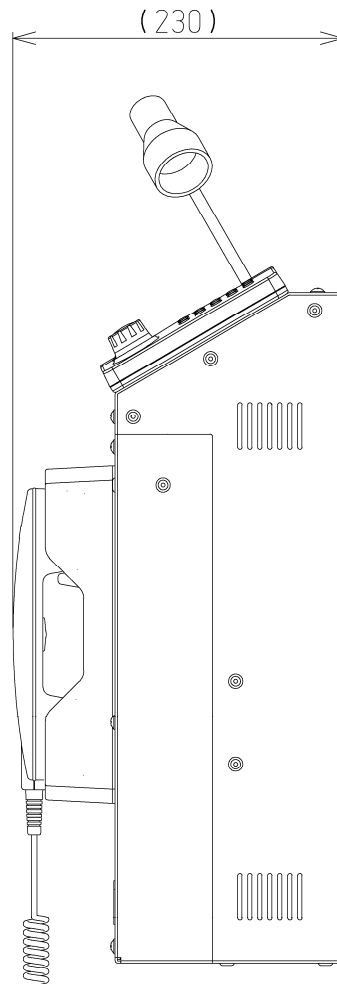
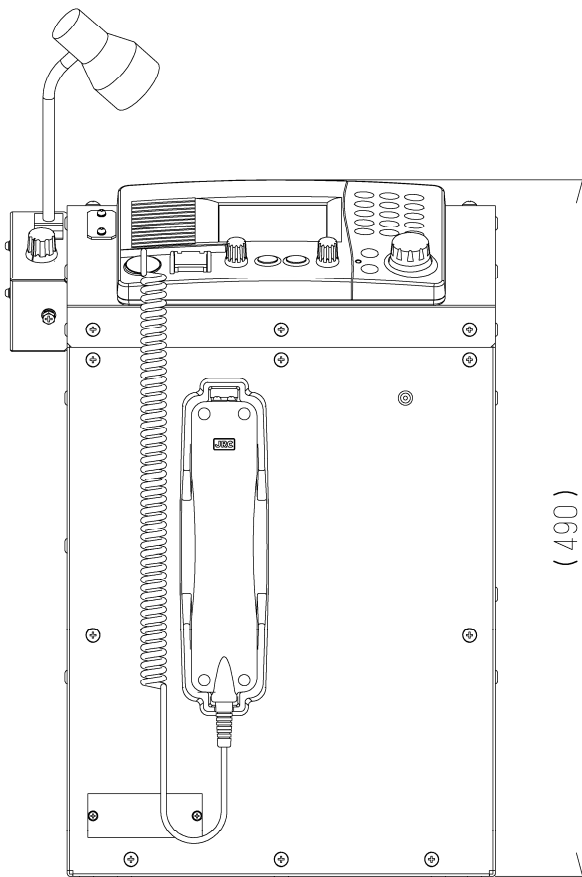
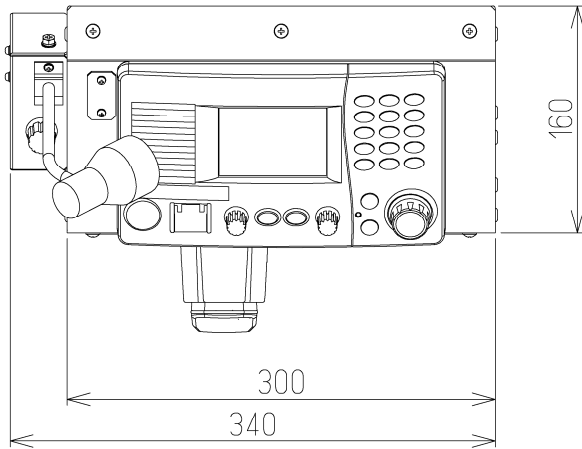

Unit: mm

Weight JHS-770S-CON: Approx. 15 kg (with NTE-770S, NCM-1770 and NQW-261)

JHS-780D-CON: Approx. 16 kg (with NTE-780D, NCM-1770 and NQW-261)

Emergency light NZL-1 is optional

1.5 Block diagram

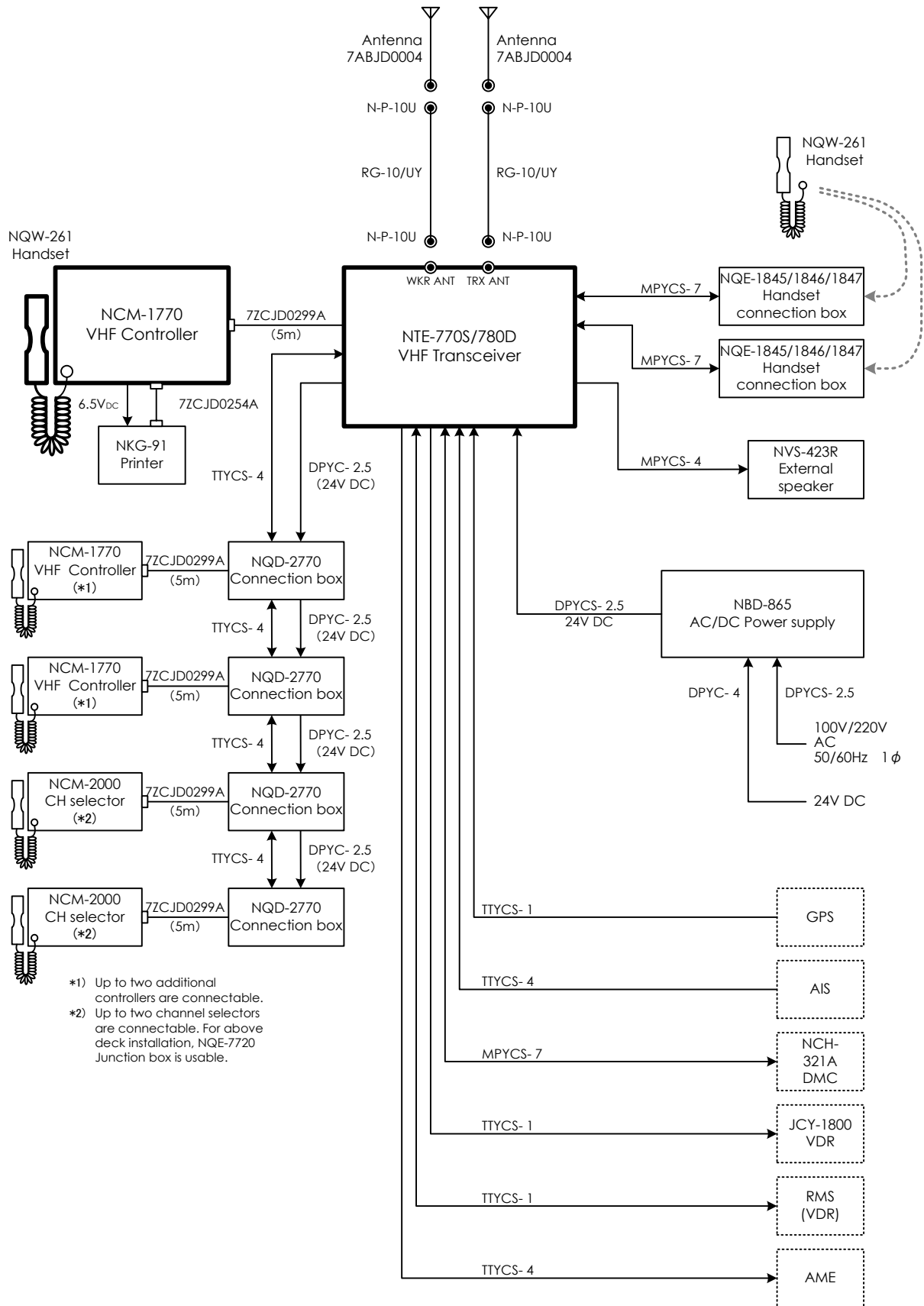

2. NAMES AND FUNCTIONS

2.1 Controller (NCM-1770)

The controller parts and their functions are described below.

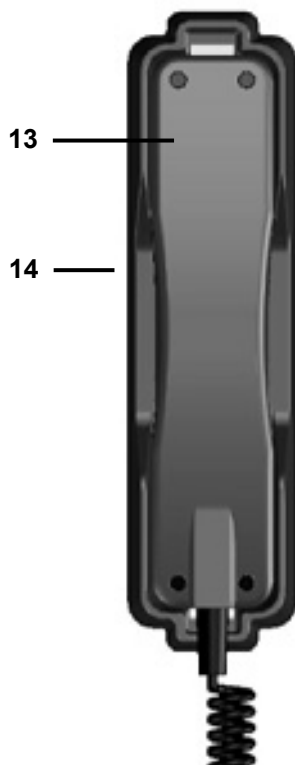
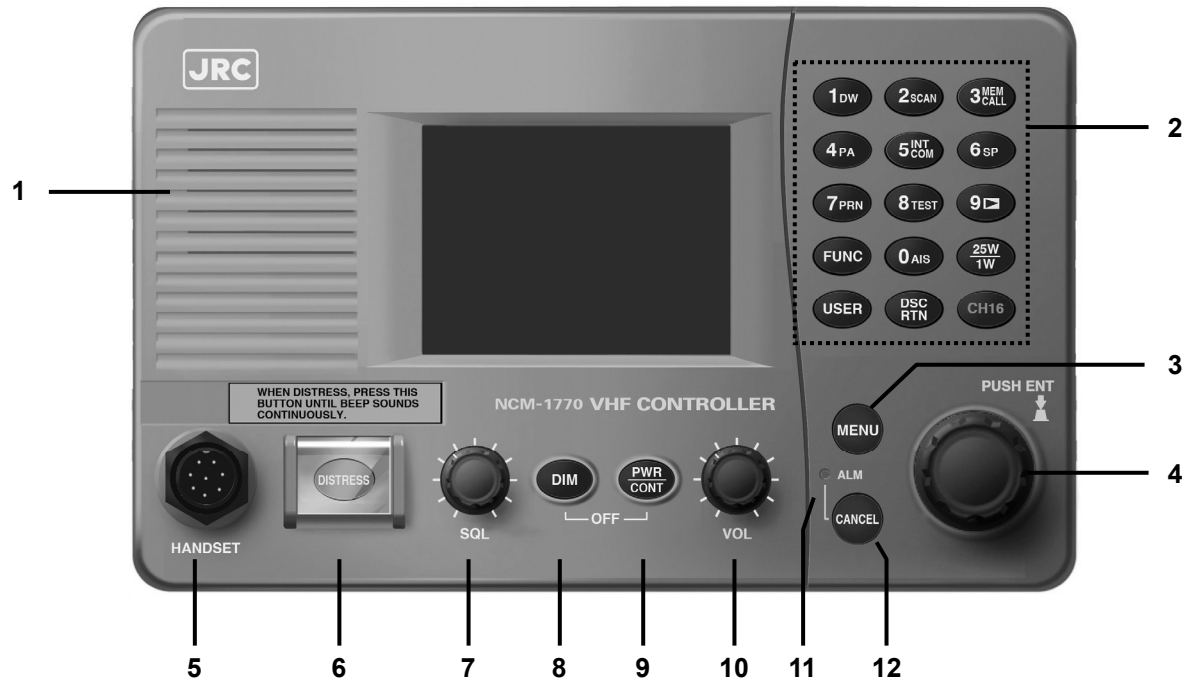

1. Internal loud speaker

2. Numeric keypad (10-key) and the each assigned function

In addition to enter numeric values, the function assigned of each keys can be used to perform the following.

- **1DW** Displays the dual watch menu
- **2SCAN** Displays the scan menu.
- **3MEM CALL** Displays the memory channel menu.
- **4PA** Runs the public address mode using an external speaker.
- **5INT COM** Displays intercom menu.
- **6SP** Turns speaker on or off.
- **7PRN** Prints the DSC messages or some displayed contents.
- **8TEST** Displays self-diagnosis menu.
- **9** Replays the recorded receiving voice.
- **0AIS** Displays "Other ships list" of the AIS information.
- **FUNC** Temporarily enables function keys mentioned above.
- **25W 1W** Switches the Tx power between 25W and 1W.

Names and Functions

- **USER**User defined key. Register a desired and assignable menu (e.g. frequently using).
- **DSC RTN**Shortcut key to a DSC routine call menu.
- **CH16**Sets the radiotelephone to the priority channel (CH16) quickly.

3. MENU key

Displays menu list.

4. Jog dial

- On the status display, rotating the jog dial will change the channel.
- On a menu or popup screen, rotating the jog dial will move the cursor position or screen contents. When selecting a button or an item on the screen, rotate the jog dial until the cursor is on it and then press the jog dial.

Note

Press the jog dial to obtain access rights from other controller.

5. Handset connector

6. DISTRESS key (Under a clear cover with spring)

When in distress, sends a DSC distress call after pressing for 4 seconds.

7. SQL (Squelch) control

Adjusts squelch level.

8. DIM (Dimmer) key

Adjusts a dimmer level (Max → Typ → Min → off) of LCD display and key switch. Additionally, used to power off by pressing it with the **PWR/CONT** key at the same time (a confirmation screen will be displayed).

Note

The adjusted dimmer level is not saved. So when the controller is powered off and on again, the dimmer level is always set to the Typ (default).

9. PWR/CONT (Power/Contrast) key

Turns on the equipment or makes the controller standby from the sleep mode. And after turned on, this key is also used to adjust the LCD contrast .

10. VOL (Volume) control

Adjusts built-in loud speaker volume.

11. ALM (Alarm) lamp

Lights up red on any malfunction detected in the equipment or after sending a DSC distress call, or blinks red on receiving a DSC call. Lights green while the controller is in the sleep mode.

12. CANCEL key

Cancels menus or stops alarms. Additionally, opens the squelch temporarily while pressing it on the status display. (channel monitor function).

13. Handset

When using in radiotelephone mode, press and hold the PTT key to talk.

14. Cradle (for handset)

2.2 Main displays

This section describes diligent displays such as the status display, menu screen, and DSC message receiving screen.

2.2.1 Status display

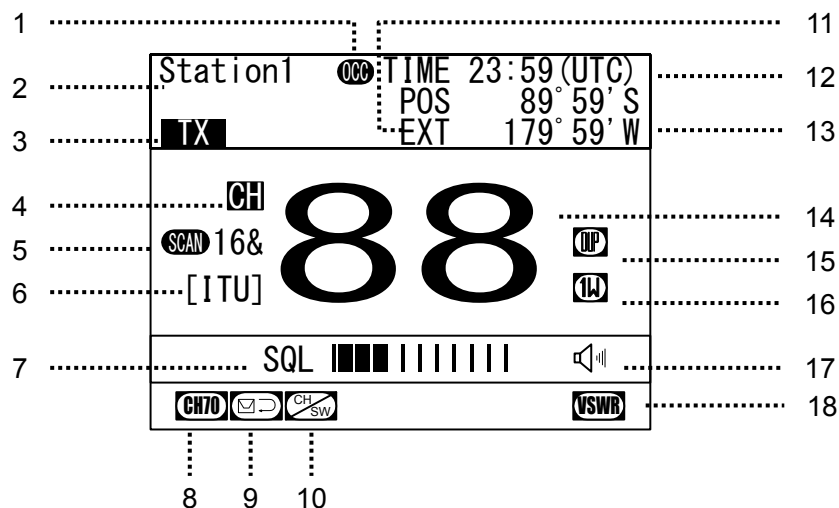

- Occupied mark indicates when the other controller has the access rights.
- Controller name.
- Transmitting or PLL unlocking mark.
 - Transmitting..... **TX**
 - PLL unlocking..... **UNLOCK**
- Indicates the channel category as follows.
 - Priority channel, CH70 **CH**
 - Private channel CH P0/1/2
 - Other channel CH
- On scanning, indicates the current condition.
 - Scanning **SCAN 16&**
 - Dual Watch **DW 16&**
- Indicates the region type of a current channel.
 - [ITU] ITU channel
 - [USA] USA channel
 - [CAN] Canada channel
 - [IWW] European inland waterway channel
- Indicates the squelch status as follows.
 - Closed..... **SQL**
 - Opened **SQL**
 - Closed by Preset SQL **p SQL**
 - Opened by Preset SQL... **p SQL**

Also, the actual squelch level is shown on this level indicator
- Indicates CH70 watching continuously by the DSC watchkeeping receiver.
- Indicates that the DSC is in the automatic acknowledgement mode.
- Indicates that the DSC is NOT in the automatic channel shift mode.
- Indicates the source of the ship's position information as follows.
 - External device (e.g. GPS) **EXT**
 - Manual input **MAN**
- Indicates current time as follows:
 - Universal time coordinated UTC
 - Local time LT
- Indicates own ship's position.
- Indicates current channel.
- Indicates if currently selected a duplex channel to communicate with a coast station.
- Indicates Tx power is set to 1W.
- Indicates the built-in loud speaker's ON/OFF. Note that in the case of using a duplex channel for the JHS-780D, when taking a handset off-hook, the loud speaker will be OFF automatically.
- VSWR alarm mark. Indicates when detected a bad VSWR at transmission.

2.2.2 Menu screen

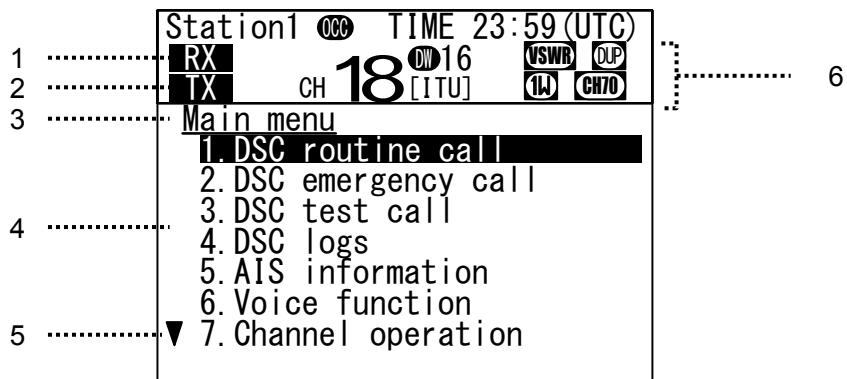

- | | |
|---|--|
| <ul style="list-style-type: none"> 1. Indicates if opened the squelch while performing one of the 6. Voice function menus. 2. Transmitting mark. 3. Indicates the current menu name. | <ul style="list-style-type: none"> 4. Indicates the menu content. The cursor line or position is highlighted. 5. Indicates that the menu content is continued below. 6. Indicates the main radiotelephone information as with the status display. |
|---|--|

2.2.3 DSC message receiving screen

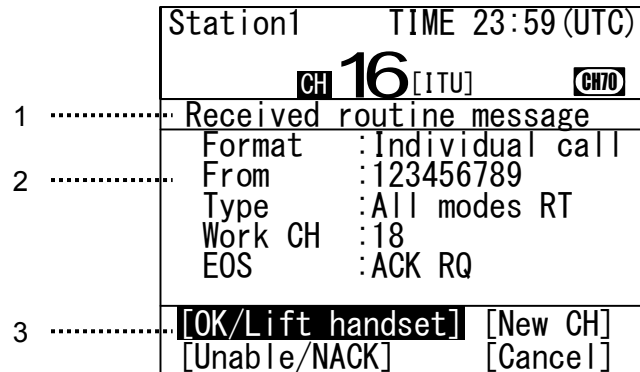

- Indicates the received message category. (Routine, Safety, Urgency, Distress)
- Indicates the received message. The example above shows the following contents.
 - Format : Individual call to own ship
 - From : The caller's MMSI is 123456789.
 - Type : Radiotelephone is proposed as a subsequent communication type.
 - Work CH : CH18 proposed as a work channel.
 - EOS : Requested the acknowledgement.
- Indicates message handling menu for received message. The example above shows the following.
 - [OK/Lift handset]
Agreed to the call, and start radiotelephone communications immediately.
 - [New CH]
Agreed to the call except the proposed channel, and reply to the call with a new channel proposal.
 - [Unable/NACK]
Not agreed to the call, and reply to the call as "unable to comply" with a reason.
 - [Cancel]
Returns to the status display without replying.

Note

- When selecting [OK/Lift handset], just lifting a handset enables to start communications without selecting this item by the jog dial.
- When selecting [New CH] or [Unable/NACK], an editing screen will appear.

3. INSTALLATION



CAUTION



Leave installation of this equipment to our service center or agents. Special knowledge on selecting the place where the antenna is to be mounted and setting the ID number (MMSI) assigned to the ship is required in addition to mounting the equipment.

4. OPERATION

This chapter describes basic controller operation, radiotelephone communication, DSC calling procedures, and other radiotelephone functions.

4.1 Controller operation overview

Basically, the controller is operated with the numeric keypad (10key), the **MENU** key, and jog dial. The following is an overview of their operation.

- When two or more controllers are connected, only one controller having the access right can operate the radiotelephone, except for sending a distress call, changing audio volume, and changing display conditions. (Unless otherwise mentioned, the instructions below are for the controller with the access rights.)
- To obtain the access right at a controller without access rights, press the jog dial or take the handset off-hook under such condition that the controller with the access rights is not in use (such as taking a handset off-hook, pressing the PTT ON, or operating menu). However note that a controller installed as a high priority can always obtain the access right if only at the PTT OFF condition.
- The **DISTRESS** key is always available even if the controller does not have the access right. (The DISTRESS key has the highest priority.)
- To verify a prepared DSC message just before sending, provides two types of verification screens: Simple mode (shows editable information only) and Detail mode (shows every information).
- On the status display, the VHF channel number can be set by using the numeric keys directly or by rotating the jog dial.
- On the status display, pressing the **CANCEL** key opens the squelch temporarily to listen to the receiving audio (or noise).
- Placing the handset back on-hook will return the channel to CH16 (factory default value). Also, the on-hook detection can be disabled at the menu 9.3-5 Hook switch.
- All functions can be accessed using the **MENU** key, jog dial, and the dedicated keys/controls. (See the menu tree of the equipment on the next page.)
- Pressing the **FUNC** (function) key and a numeric key allows rapid access to that function.
- There are two ways to access main menu items. After pressing the **MENU** key to display the main menu, use either the jog dial to move the cursor to the desired item and press ENT to select it, or select the item by pressing the respective numeric key. (e.g. To select a menu for safety call to all ships (2.1.1 All Ships), press **MENU** → **2SCAN** → **1DW** → **1DW** .)
- Any menu can be assigned to the **USER** key to quickly open it with a single touch of a key.
- Pressing the **CANCEL** key in any menu moves the display up one level in the hierarchy (or to the status display). The same results can be achieved by selecting "0. Back" when available on-screen.. Further, pressing the **CANCEL** key on an input line will clear the entered data.
- Pressing the **MENU** key in any menu opens the main menu. Also, pressing the **MENU** key while in the main menu returns to the status display.
- If no operations are done for 10 minutes while a menu is open, the screen automatically returns to the status display.
- Dialog boxes (pop-up screens) are opened when necessary and operations can be done in the dialog box.
- Screens in the menu tree on the following page indicated by "Printable" can be printed from a printer connected to the controller by pressing and holding the **Func** key and then pressing the **7PRN** key.
Additionally, if not connected to the controller but the transceiver, the screen or contents will be printed out from the printer of the transceiver.

Menu tree

Main Menu	Hierarchical Menu 1	Hierarchical Menu 2	Shortcut Key	Note	
1. DSC routine call	1.1) Coast station call				
	1.2) Ship station call		DSC RTN		
	1.3) PSTN call				
	1.4) Group call				
2. DSC emergency call	2.1) Safety call	2.1.1) All ships			
		2.1.2) Specific station			
	2.2) Urgency call	2.2.1) All ships			
		2.2.2) Specific station			
	2.3) Distress call		DISTRESS		
	2.4) Proxy distress call	2.4.1) All ships			
2.4.2) Coast station					
3. DSC test call					
4. DSC logs	4.1) Received distress	(Received distress list)		Printable	
	4.2) Received others	(Received others list)		Printable	
	4.3) Transmitted calls	(Transmitted calls list)		Printable	
5. AIS information - Other ships list - Proximity check - Proximity range	5.1) Other ships list		FUNC→0	DSC linking enable	
6. Voice function	6.1) Playback		FUNC→9		
	6.2) Public address		FUNC→4		
	6.3) Intercom (station list)		FUNC→5		
7. Channel operation	7.1) Scan - All CH scan - Memory CH scan - Select CH scan		FUNC→2		
		7.2) Dual watch	FUNC→1		
		7.3) Memory channel	7.3.1) Memory CH list	FUNC→3	Printable
	7.3.2) Registration				
	7.4) Private channel			Printable	
	7.5) Weather channel			Printable	
	7.6) Region	(ITU/USA/CAN/IWW)			
	7.7) CH SQL setting - Preset - All clear			CANCEL pressing FUNC	
8. Maintenance	8.1) Self diagnosis	8.1.1) Transceiver	FUNC→8	Printable	
		8.1.2) Controller		Printable	
		8.1.3) Transceiver log		Printable	
		8.1.4) Controller log		Printable	
		8.1.5) DSC loop		Printable	
	8.2) Alarm information	Alarm history		Printable	
	8.3) System information			Printable	
	8.4) Software version			Printable	
8.5) DSC AF inspection	(inspection screen)				
9. Setup	9.1) Date & time			Clock setting	
	9.2) POS/TIME				
	9.3) My controller - LCD adjustment - Sound - User key assign - Name - Hook switch - Off-hook notice	9.3.1) LCD adjustment			
		9.3.2) Sound		FUNC→6 (SP)	
		9.3.3) User key assign			
	9.4) Contact list	9.4.1) Coast station list			Printable
		9.4.2) Ship station list			Printable
		9.4.3) Calling group list			Printable
		9.4.4) PSTN number list			Printable
	9.5) DSC operation - Automatic ACK - Automatic CH shift - Safety/Routine ALM - Medical/Neutral use - Expanded MMSI				Printable
9.6) AIS function					
9.7) Printer property	9.7.1) Controller printer			Printable	
	9.7.2) Transceiver printer			Printable	

4.2 Basic communication procedure

The following describes basic radio communication procedures.

4.2.1 Turning ON the power



CAUTION



Do NOT turn off the power of the equipment when at sea because the SOLAS Convention requires keeping CH16 watch at all times.

■ Procedure ■

1. Press the  key for one second.

The controller and transceiver will start the internal check. After finished it correctly, the status display will appear. (The screen at right shows the case of the JHS-770S Model.)

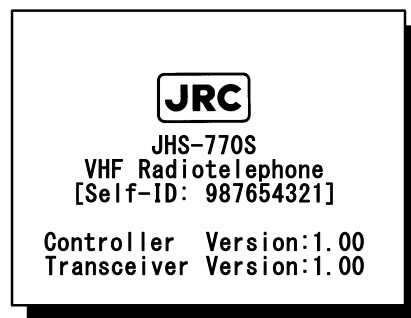

- Note**
- When the controller is turned on from sleep mode, the status display will be displayed immediately without checking the memory.
 - If detected errors during the memory check, displays the message below. Please inform JRC or our agent of the error contents.

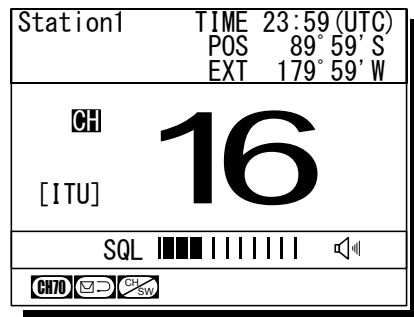

Message	Contents
Detected memory error! So cleared the area of transceiver memory.	Detected a memory error when starting the transceiver.
Detected memory error! So cleared the area of controller memory.	Detected a memory error when starting controller.
Detected this controller's address setting error! So required initial set after restarting as the maintenance mode	Detected this controller's address error when starting the controller.
Detected SIO error! So required initial set after restarting as the maintenance mode.	Detected a serial error when starting controller.
Detected MMSI lost! So concerned functions (DSC/ATIS) no longer available now.	Unregistered MMSI yet, or lost the MMSI. So required to install MMSI for DSC/ATIS.
Detected the transceiver's PCB combination error! So required to replace that incorrect PCB with the correct one.	Detected the improper transceiver's PCB combination.

4.2.2 Turning OFF the power

■ Procedure ■

1. Press the **PWR CONT** key and the **DIM** key simultaneously.

After that, the power-off process is activated according to the controllers' situation.

When using only one controller

Select the desired item below on the displayed popup screen at right.

- [OK]: Turns off the power.
- [Cancel]: Returns to the previous screen.

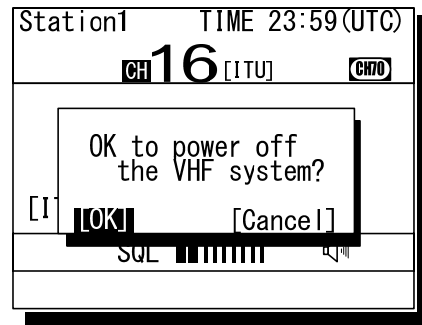

When using two or more controllers

Select the desired item below on the displayed popup screen at right.

- [OK]: Turns off the power.
- [Sleep]: Sets the controller to sleep mode.
- [Cancel]: Returns to the previous screen.

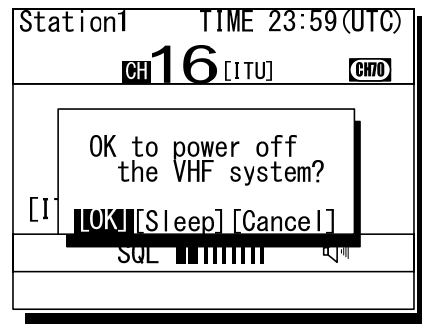

Note

In sleep mode, the controller becomes the following conditions.

- Only the controller is powered off.
- The ALM lamp turns green to indicate that the controller is in sleep mode,
- When receiving a distress call, the controller will be automatically turned on and activate the alarm if the Wake-up setting in an installation menu is ON,.
- Even if set the controller with access right to the sleep mode, the access right will not move from the controller.

4.2.3 Communicating with the radiotelephone

The VHF radiotelephone is operated by means of a handset.

■ Procedure ■

1. When operating on a controller without the access rights (OCC is displayed), press the jog dial to obtain the access right.

After obtaining the access right, disappears OCC mark on the screen and the controller becomes accessible to the VHF transceiver. Also, just lifting a handset from the cradle enables to obtain the access right.

Note When hook-switch setting is invalid, the access right cannot be acquired by lifting handset from the cradle.



2. Adjust the volume on the loudspeaker by turning the volume control.

When receiving no signal, make a noise as a guide by turning the squelch control counterclockwise until opened.



3. Turn the squelch control to an appropriate position.

Normally, the squelch control would be adjusted to where rotated the squelch control clockwise one additional tick from the squelch closing position.



4. Lift the handset from the cradle.

5. Press the PTT key to talk.

- The **TX** mark will appear on the screen to show the equipment is transmitting. Releasing the PTT key will return to the receiving condition.
- On duplex channels, enabled to listen to the receiving audio even during the PTT ON.
(In the case of the JHS-780D model.)

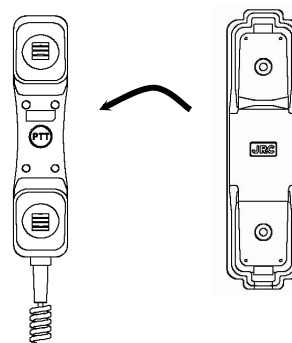

6. If necessary, change the channel using the numeric keypad or jog dial.

Channels can be changed as long as showing the status display and releasing the PTT key. Additionally, when entering the channel using the numeric keypad, e.g. in case of CH18, enter **1**DW **8**TEST .



7. When finished the communication, return the handset to the cradle.

Note Placing the handset back on-hook will return the channel to CH16. When hook-switch setting is invalid, a channel is not changed by returning the handset to the cradle.

■ Making a radiotelephone call ■

1. Select CH16 or other agreed channel.
2. Lift the handset from the cradle.
3. Press the PTT key, and make a call as described below.
 - Say the calling station name ... Repeat 3 times.
 - "this is"
 - Say own ship name ... Repeat 3 times.
 - "over"
4. Release the PTT key to listen.
5. When answered and agree on a working channel, change to that channel.
6. After checking that no station uses the working channel, begin conversation.

Note

- When transmitting from own station, always press the PTT key while talking.
- On a simplex channel, always say "over" just before releasing the PTT key.
- Always say "out" when terminating communications.

■ Receiving a call on CH16 ■

1. Lift the handset from the cradle.
2. Press the PTT key, and respond to the call as described below.
 - Say the caller station name.
 - "this is"
 - Say own ship name.
3. Propose a channel other than 16 as described below.
 - "channel"
 - Working channel number
4. Allow the caller station to transmit.
 - "over"
5. Release the PTT key, wait a moment, and then switch to the proposed working channel.
6. After checking that no station uses the working channel, begin conversation.

Note

- When transmitting from own station, always press the PTT key while talking.
- On a simplex channel, always say "over" just before releasing the PTT key.
- Always say "out" when terminating communications.

4.2.4 Receiving with scanning

Scanning function enables to watch multiple channels (additional channels) with the priority channel (CH16). If found receiving signal on the additional channels, the dwell time on that channel will be longer, but continued to watch the CH16 alternatively. The scan mode can be selected from the following modes.

- All CH scan Mode: Scans all channels in the current channel mode.
- Memory CH scan Mode: Scans all memory channels.
- Select CH scan Mode: Scans the specified range of channels.

■ Procedure ■

1. Press **FUNC** → **2SCAN**.

The menu will be displayed as shown at right.

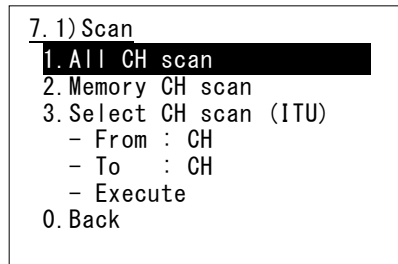

2. Move the cursor to the desired item and press ENT using the jog dial, or press the item number by a numeric key directly.

- If selected "1. All CH scan" or "2. Memory CH scan", scanning starts immediately.
- If selected "3. Select CH scan", specify the channel range as described below.

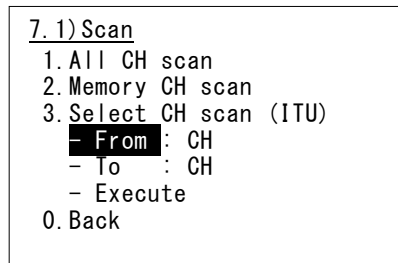

- 1) To set the start channel (From): Press ENT and after entering the channel number, press ENT again.
- 2) To set the stop channel (To): Press ENT and after entering the channel number, press ENT again.
- 3) To start the scanning: Select Execute and press ENT. Then starts the scanning as shown at right.

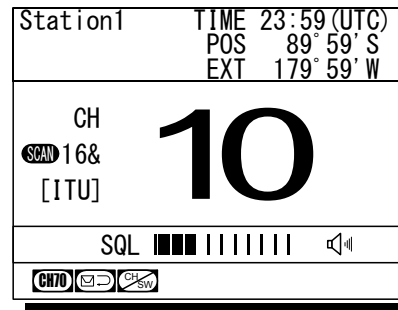

- Note**
- Disabled to scan when the channel region is Inland Waterways (IWW).
 - CH70 will be skipped, even if contained in the scanning range.

3. To terminate scanning, press the **CANCEL** key.

- After terminated, the radiotelephone will be set on the last additional channel. (The example at right shows when stopped on CH12.)
- Scanning will be also terminated when detected off-hook, PTT ON, or press the **CH16** key or the **DISTRESS** key.

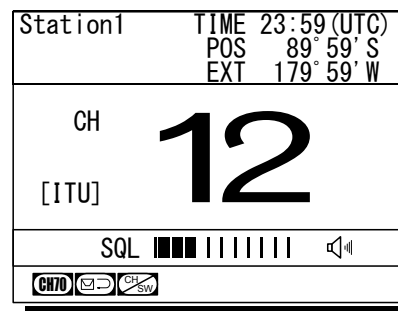

- Note**
- While scanning, the radiotelephone scans CH16 and the additional channels alternatively in a cycle of 0.14/0.86 seconds.
 - If the squelch is opened on the CH16, paused scanning and continues to watch on

- the CH16. If squelch is closed again, the scanning will resume 2 seconds later.
- If the squelch is opened on an additional channel, remains on that channel and CH16 alternatively (in a cycle of 0.14/1.86 seconds). If squelch is then continuously closed (until the end of the scan cycle), the scanning will resume. Furthermore, added to the additional channel, if the squelch is also opened on the CH16, paused scanning and continues to watch on the CH16 as described above.

4.2.5 Receiving with dual watch

Dual watch function enables to watch an additional channel with the priority channel (CH16). If found receiving signal on the additional channel, the dwell time on that channel will be longer, but continued to watch the CH16 alternatively.

■ Procedure ■

1. Select an additional channel to be watched with CH16.

The example at right shows the case of CH10 selected.

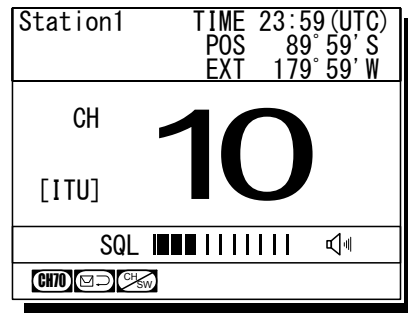

2. Press **FUNC** → **1DW**

The dual watch will start immediately.

Note Disabled the dual watch either when the channel region is Inland waterways (IWW) or when CH70 has been selected.

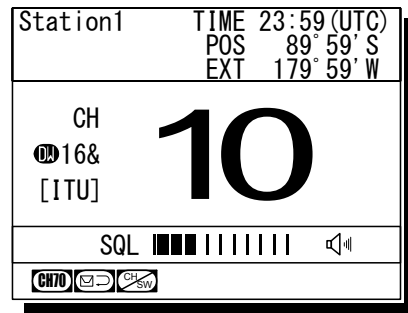

3. To terminate the dual watch, press the **CANCEL** key.

- After terminated, the radiotelephone will be set on the additional channel. (The example at right shows when stopped on CH10.)
- The dual watch will be also terminated when detected off-hook, PTT ON, or press the **CH16** key or the **DISTRESS** key.

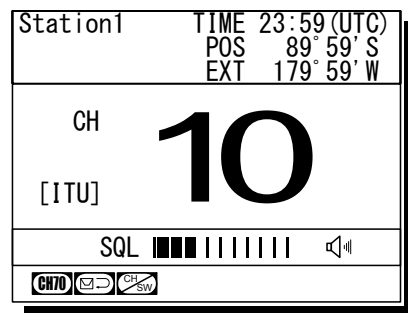

- Note**
- During the dual watch, the radiotelephone watches CH16 and the additional channel alternatively in a cycle of 0.14/0.86 seconds.
 - If the squelch is opened on the CH16, pauses the dual watch and continues to watch on the CH16. If squelch is closed again, the dual watch will resume 2 seconds later.
 - If the squelch is opened on the additional channel, the dwell time on that channel will be longer, but continues to watch the CH16 alternatively (in a cycle of 0.14/1.86 seconds). If squelch is then continuously closed (until the end of the dwell time), the dual watch will resume. Furthermore, added to the additional channel, if the squelch is also opened on the CH16, pauses the dual watch and continues to watch on the CH16 as described above.
 - This function is also available from the menu 7.2 Dual watch.

4.2.6 Using memory channels

Memory channels are the original channel list. The desired channels (e.g. frequently using channel) can be registered and used for easy access.

(1) Registering memory channels

■ Procedure ■

1. Press the **MENU** key and, through hierarchical menus, select 7.3.2 Registration.

The registration menu of the 7.3 Memory channel will be displayed as shown at right.

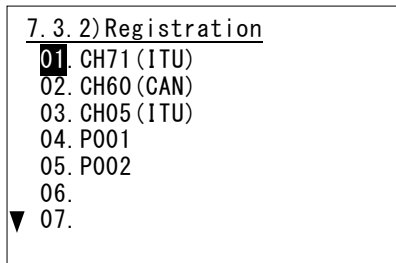

2. Move the cursor to the desired list number and press ENT using the jog dial, or press the memory channel number (two digits) by numeric keys directly. Then select a channel type.

First, **CH** will be displayed. Select a channel type by turning the jog dial (CH → P0 → P1 → P2 → W → CL), or clear the channel type.

The content of each type is as described below.

- CH : Region channel
- P0/1/2 : Private channel (with a hundred digit)
- W : Weather channel
- (CL : Deletes the memory channel)

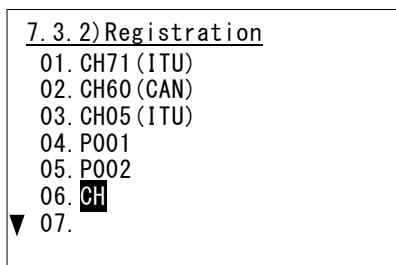

3. Press ENT after selecting a channel type. Then input the channel number using the jog dial or numeric keys.

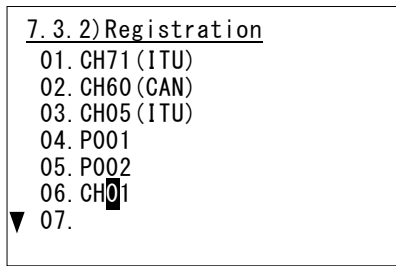

4. Press ENT after inputting the channel number. Then select the channel region. (If selected a private or weather type at step 2, skip this step.)

First, **(ITU)** will be displayed. Select a channel region by turning the jog dial (ITU → USA → CAN → IWW).

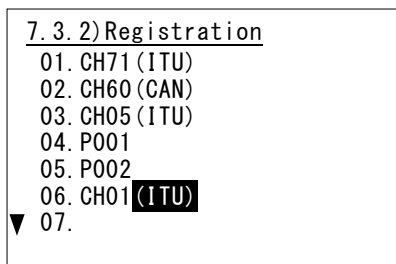

Operation

5. Press ENT after finished the steps above. Then saved the memory channel number and the cursor moves to the next number.

When registering other channels or revising existing lines, repeat the steps 2 - 5 above.

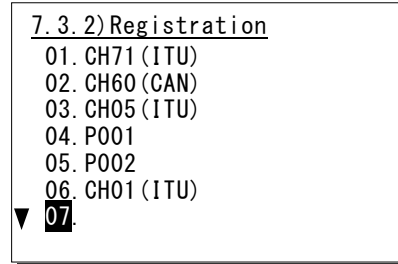

Note

- The above procedures are for registering a channel in an empty line. However editing an existing memory channels is as well.
- To delete a registered memory channel, select CL at step 2 of the procedure above.

(2) Communicating on a memory channel

Memory channels will be available e.g. when setting a working channel for subsequent communication after initial contact on CH16.

■ Procedure ■

1. Press **FUNC** → **3** ^{MEM} _{CALL}.

The 7.3.1 Memory CH list will be displayed as shown at right.

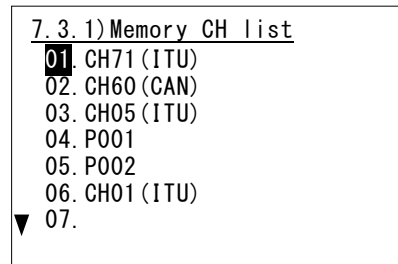

2. Move the cursor to the desired list number and press ENT using the jog dial, or press the memory channel number (two digits) by numeric keys directly.

In this example, if selected the memory channel number 05, CH P002 will be set.

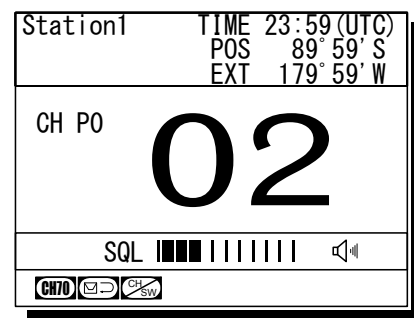

4.2.7 Communicating on a private channel

Private channels for assigned frequencies of fishing ship or other specially assigned frequencies are registered at the installation of equipment. Up to 200 channels are available for radiotelephone communications. (If required to add channels after installation, please contact JRC or our agent.)

■ Procedure ■

1. Press the **MENU** key, and through hierarchical menus, select the 7.4 Private channel.

Indicates the information of the highlighted line by the cursor on the bottom of the screen.

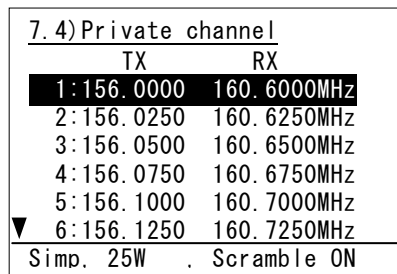

2. Move the cursor to the desired channel number and press ENT using the jog dial, or press the private channel number (three digits) by numeric keys directly.

In this example, if selected the CH P200, the screen will become as shown at right.

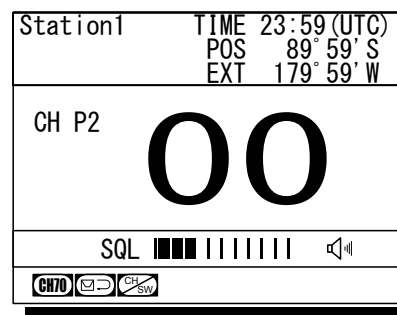

4.2.8 Receiving a weather channel

Weather channels are available to receive weather information on the North American coast.

■ Procedure ■

1. Press the **MENU** key, and through hierarchical menus, select the 7.5 Weather channel.

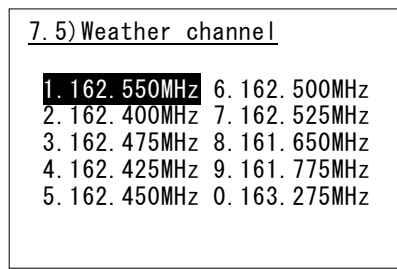

2. Move the cursor to the desired line and press ENT using the jog dial, or press a numeric key directly.

When selected the channel 8, the screen will become as shown at right.

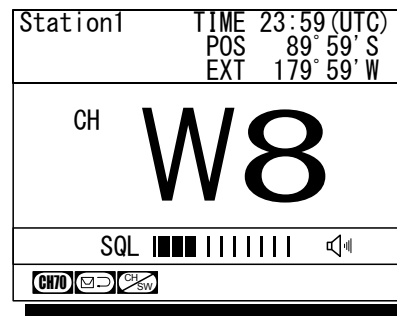

Note Disabled to transmit on weather channels.

4.2.9 Changing the channel region

This menu sets the channel region to ITU, USA, Canada, or Inland Waterway.

■ Procedure ■

1. Press the **MENU** key, and through hierarchical menus, select the 7.6 Region.

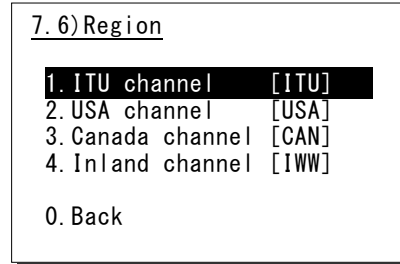

2. Move the cursor to the desired line and press ENT using the jog dial, or press a numeric key directly.

When selected the USA channel, the screen will become as shown at right.

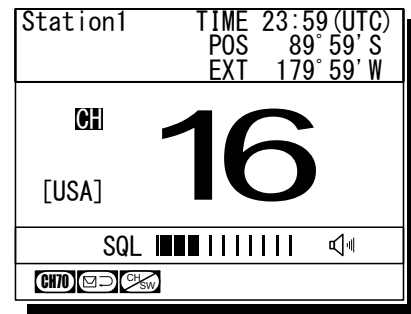

- Note** When set to the Inland Waterway (IWW), changed a few functions as follows.
- Enabled the ATIS function automatically and sends the ATIS code over the voice channel when releasing the PTT key. Also, if pressed the PTT key continuously, sends the ATIS code every five minutes automatically.
 - Disabled the scan or dual watch functions.
 - When operating the DSC menus, a popup screen will be displayed to notice that the DSC usage is not allowed on Inland Waterways.

4.2.10 Squelch settings of each channel (preset squelch)

The adjusted squelch value can be stored with respect to each channel as a preset squelch. The handling of the preset squelch will be as follows.

- If stored the squelch value, the preset squelch will be always set just after the channel selection.
- While the preset squelch has been set, "p SQL" will be indicated on the status display.
- If turned the SQL control after setting the preset channel, the preset value will be canceled immediately and the SQL control will be available.
- The preset squelch value can be cleared with respect to each channel or each channel region.

■ Procedure ■

1. After selecting the desired channel, press the **MENU** key and through hierarchical menus, select the 7.7 CH SQL setting.

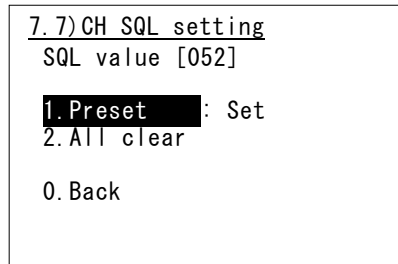

2. Turn the SQL control to the appropriate position.

The SQL value as shown at right will be changed corresponding to the SQL control position.

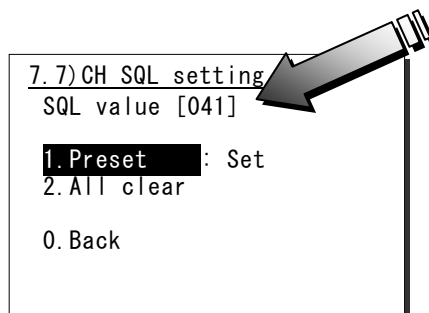

3. Press ENT.

The cursor will move to the right.

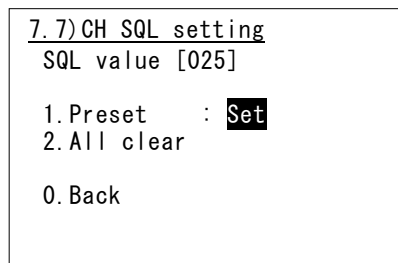

4. To complete the squelch setting for the channel, select "Set" and press ENT.

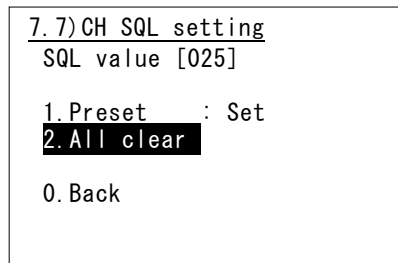

Note

- To clear the preset squelch values with respect to each channel, after selecting the channel, select Erase and press ENT at the step 3 above.
- To clear the preset squelch values with respect to each channel region, in the condition of that channel region, move the cursor to the 2. All clear and press ENT.
- The above operation is also available on a popup menu displayed when pressed both of the **FUNC** key and the **CANCEL** key simultaneously on the status display.

4.3 Basic DSC operations

When calling stations, the DSC is also available for a routine/ safety/ urgency or a distress call in addition to the calling by radiotelephone described above. This section describes the procedures for basic DSC routine calls and for the AIS-linked DSC calls.

4.3.1 Routine calls to a coast station

A DSC call to a coast station is initiated as follows.

■ Procedure ■

1. Press the **MENU** key, and through hierarchical menus, select the 1.1 Coast station call.

The address inputting screen will be displayed. If entered previously, the address will be appeared as a default value.

1.1)Coast station call
Address : [00]
[OK] [Cancel]

2. Press ENT to display the alphabetically sorted coast station list. After selecting the initial letter and pressing ENT, select the desired coast station with the jog dial.

Note

- This list can be registered in the menu 9.4.1 Coast station list.
- When inputting the MMSI manually, press the **CANCEL** key to return to the previous screen and input it using the numeric keypad.

NAME	MMSI
Argentina	001234567
Australia	002222222
Azerbaijan	003333333
Bolivia	004444444
▼ Bangladesh	005555555

Select the initial of the name.
ABCDEFGHIJKLMN OPQRSTUVWXYZ

3. After inputting the address, press ENT.
Confirm the address.

1.1)Coast station call
Address : [001234567]
[OK] [Cancel]

4. If the address is correct, press ENT.

The sending confirmation screen will appear.

Note

- The controller displays by default only the edited information in the call setup as shown at right.

1.1)Coast station call
Address : 001234567
[Call] [Cancel]

5. Press ENT to transmit the call.

After completed the transmission, the popup screen shown at right will be displayed to wait the acknowledgement.

Note If received no response for 5 minutes, the screen will return to the step 3 mentioned above.

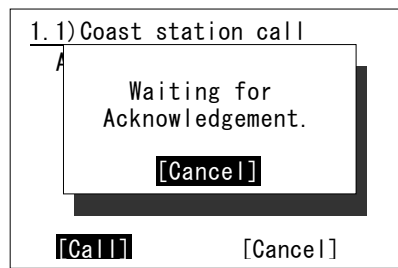

6. When received the acknowledgement, the screen shows the message with the alarm for 3 sec. Then changes to the working channel proposed by the coast station automatically.

Note

- If 9.5.2 Automatic CH shift is OFF, lifting the handset or pressing ENT is required to set the proposed working channel.
- If an improper channel is proposed, resend the call containing a new channel via the specified new channel proposal form screen.

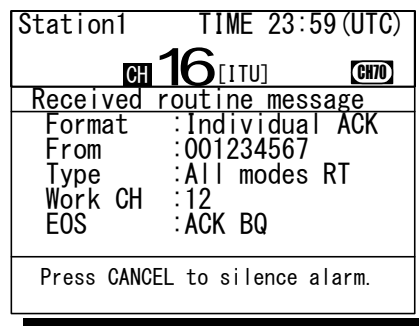

7. The coast station call will be completed after displayed the working channel as shown at right.

Start communications using the handset.

- The example at right shows when proposed CH12 as a working channel.
- When completed the communications, return the handset to the cradle.

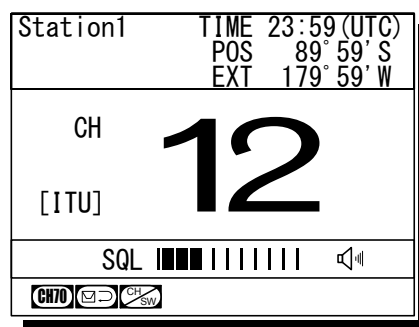

Note If the coast station is unable to comply with the call, own station (caller) may receive one of the following responses may be received. In these cases, if possible according to the message, wait and retry the calling again later.

Message	Content
No reason	No reason.
Congestion	The marine exchange center is congested.
Busy	Busy.
Queue	The call has been queued.
Barred	The station is closed.
No operator	Existing no operator.
Temp no oper	The operator is temporarily away.
EQP disabled	The equipment has been disabled.
Unable channel	The proposed channel cannot be used.
Unable mode	The proposed mode cannot be used.

4.3.2 Routine calls to a ship station

A DSC call to a ship station is initiated as follows. This procedure is similar to that of menu 1.1 Coast station call but also needed to input a working channel.

■ Procedure ■

1. Press the **DSC RTN** key.

The menu shown at right will be displayed. If entered previously, the address will be appeared as a default value.

```

1.2) Ship station call
Address : [      ]
Work CH : [  ]

[ OK ]           [Cancel]
    
```

2. Press ENT to display the alphabetically sorted ship station list. After selecting the initial letter and pressing ENT, select the desired ship station with the jog dial.

- Note**
- The list can be registered in the menu 9.4.2 Ship station list.
 - When inputting the MMSI manually, press the **CANCEL** key to return to the previous screen and input it using the numeric keypad.

Ship station list [A]	
NAME	MMSI
AAA ocean	123456789
ABB ocean	222222222
ACC ocean	333333333
ABC ocean	444444444
▼BBB ocean	555555555

Select the initial of the name.
ABCDEFGHIJKLMNOPQRSTUVWXYZ

3. Press ENT.

The cursor will move to the Work CH.

```

1.2) Ship station call
Address : [123456789]
Work CH : [  ]

[ OK ]           [Cancel]
    
```

4. Press ENT and input the working channel.

- Note**
- The free channel will be searched and displayed automatically.
 - If required, input another channel manually using the **CANCEL** key, the jog dial or the numeric keys.
 - If there is no free channel, a blank will be shown as a search result.

```

1.2) Ship station call
Address : [123456789]
Work CH : [06]

[ OK ]           [Cancel]
    
```

5. Press ENT.

Confirm the entered contents.

```

1.2) Ship station call
Address : [123456789]
Work CH : [06]

[ OK ]           [Cancel]
    
```

6. If the contents are correct, press ENT.

The sending confirmation screen will appear.

Note The controller displays by default only the edited information in the call setup as shown at right.

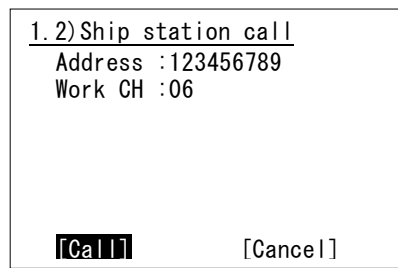

7. Press ENT to transmit the call.

After completed the transmission, the popup screen shown at right will be displayed to wait the acknowledgement.

Note If received no response for 5 minutes, the screen will return to the step 5 mentioned above.

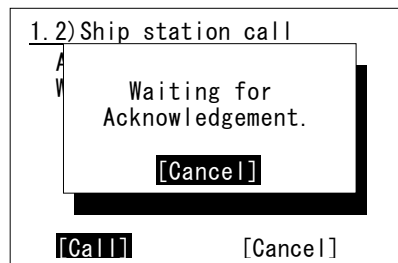

8. When received the acknowledgement, the screen shows the message with the alarm for 3 sec. Then changes to the proposed working channel automatically.

Note

- If 9.5.2 Automatic CH shift is OFF, lifting the handset or pressing ENT is required to set the proposed working channel.
- If an improper channel is proposed, resend the call containing a new channel via the specified new channel proposal form screen.

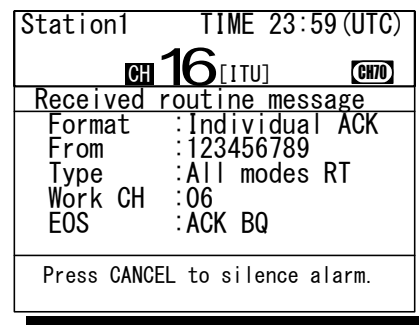

9. The ship station call will be completed after displayed the working channel as shown at right.
Start communications using the handset.

- The example at right shows when proposed CH06 as a working channel.
- When completed the communications, return the handset to the cradle.

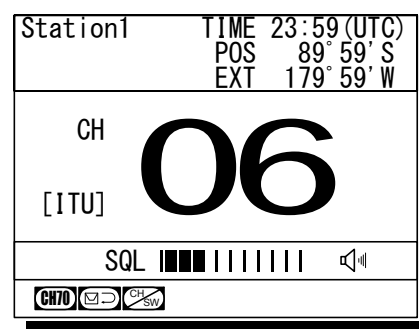

Note

- If the ship station is unable to comply with the call, as with coast stations, own station (caller) may receive a negative acknowledgement mentioned above section. In this case, if possible according to the message, wait and retry the calling again later.
- When calling group ships to broadcast, use the menu 1.4 Group call as with this procedure except for steps 7 and 8.

4.3.3 Receiving a routine call

When receiving a DSC call from a coast or ship station, the message will be displayed immediately on the screen. After that, perform the following procedures as appropriate.

(1) Receiving an individual call (type: radiotelephone)

■ Procedure ■

1. The screen at right will be displayed, and the alarm will sound.

This example message contains the following information.

- Format: Individual call
- Caller's MMSI: 111222333
- Type: All modes radiotelephone
- Work channel: CH12
- EOS: ACK is requested.

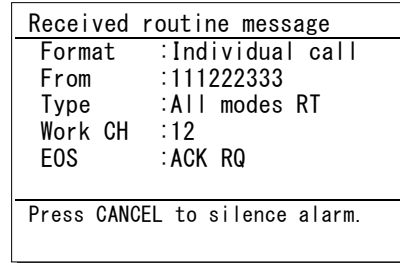

2. Press the **CANCEL** key to stop the alarm and display the screen at right.

Note This step is omissible.

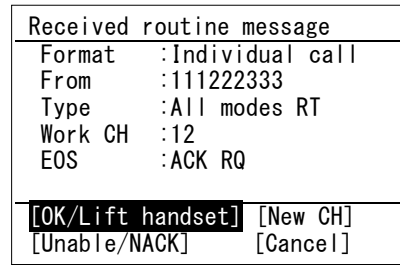

3. If possible to communicate immediately, lift the handset from the cradle and start the communications.

➤ In this example case, enabled to select the response from below with the jog dial.

- OK/Lift handset : Starts communications immediately.
- New CH : Proposes a new channel.
- Unable/NACK : Sends "Unable to comply" message with that reason.
- Cancel : Returns to the status display without handling this message.

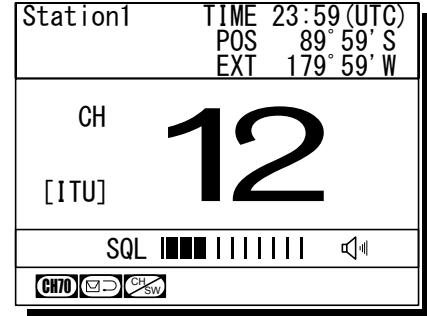

➤ When completed the communications, return the handset to the cradle.

Note When selected "Unable/NACK", also select a reason from the list given below.

Message	Content
No reason	No reason.
Busy	Busy.
Barred	The station is closed.
No operator	Existing no operator.
Temp no oper	The operator is temporarily away.
EQP disabled	The equipment has been disabled.
Unable channel	The proposed channel cannot be used.
Unable mode	The proposed mode cannot be used.

(2) Receiving an individual call (type: polling)

■ Procedure ■

1. The screen at right will be displayed, and the alarm will sound.

This example message contains the following information.

- Format: Individual call
- Caller's MMSI: 001234567
- Type: Polling
- EOS: ACK is requested.

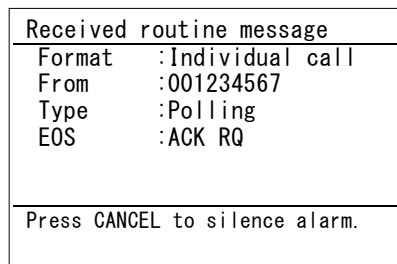

2. Press the **CANCEL** key to stop the alarm and display the screen at right. If possible to respond immediately, press ENT.

Note If Automatic ACK is ON, the acknowledgement will be sent automatically without notice.

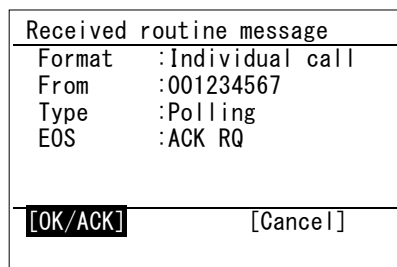

(3) Receiving a group call

■ Procedure ■

1. The screen at right will be displayed, and the alarm will sound.

The example message contains the following information.

- Format: Group call
- Caller's MMSI: 111222333
- Type: All modes radiotelephone
- Work Channel: CH12
- EOS: EOS

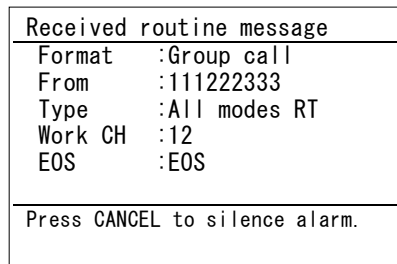

2. Press the **CANCEL** key to stop the alarm and display the screen at right.

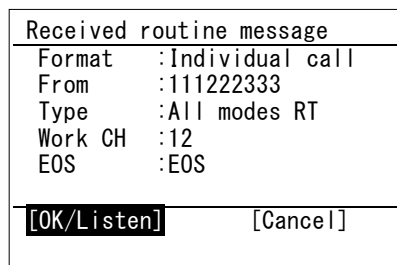

3. If possible to listen to the broadcast, press ENT, and set to the working channel.

When finished the broadcast, press the **CH16** key to return to the status display.

Note If Automatic CH shift is ON, the working channel will be changed automatically and the above step 2 and 3 are omitted.

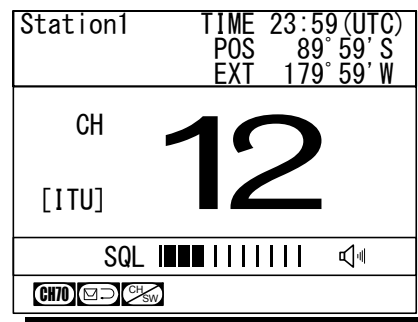

4.3.4 Communicating with a PSTN subscriber

The semi/auto mode is available to connect with a public telephone network (PSTN) via a coast station.

(1) Make a call to a PSTN subscriber

■ Procedure ■

1. Press the **MENU** key, and through hierarchical menus, select the menu 1.3 PSTN call.

The menu shown at right will be displayed. If entered previously, the address and the TEL number will be appeared as a default value. Additionally, in the case of JHS-780D, "Type" line will be shown to select the mode from "All modes RT" or "Duplex RT".

```

1.3)PSTN call
Address: [00      ]
TEL No. : [          ]

[ OK ]           [Cancel]
    
```

2. As with the routine calls mentioned above, enter the address and press ENT.

The cursor will move to the TEL No.

```

1.3)PSTN call
Address: [001234567]
TEL No. : [          ]

[ OK ]           [Cancel]
    
```

3. Press ENT to display the alphabetically sorted TEL number list. After selecting the initial letter and pressing ENT, select the recipient of the call with the jog dial.

Note

- This list can be registered in the menu 9.4.4 PSTN number list.
- When inputting the TEL number manually, press the **CANCEL** key to return to the previous screen, and input it using the numeric keypad.

TEL number list [A]	
NAME	Heading num
Alex	11223344556
Andy	00125412345
Arnold	01011448851
Blanco	00102875521
▼ Bob	001149586

Select the initial of the name.
ABCDEFGHIJKLMNOPQRSTUVWXYZ

4. Press ENT.

Confirm the entered contents.

```

1.3)PSTN call
Address: [001234567]
TEL No. : [1122334455667788]

[ OK ]           [Cancel]
    
```

5. If the contents are correct, press ENT.

The sending confirmation screen will appear.

Note The controller displays by default only the edited information in the call setup as shown at right.

```

1.3)PSTN call
Address :001234567
TEL No. :1122334455667788

[Call]          [Cancel]
    
```

6. Press ENT to transmit the call.

After completed the transmission, the popup screen shown at right will be displayed to wait the acknowledgement for 5 sec.

Note If received no response within 5sec, sends the call again. Still no response, the following will be displayed and this call will be terminated.
"Coast sta no answer."

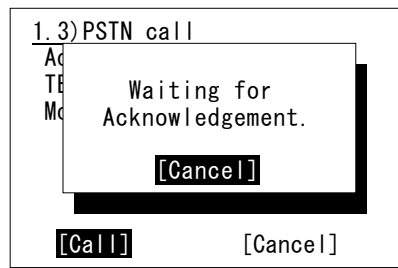

7. After received the acknowledgement, the specified working channel will be set automatically.

After that, a start of call will be sent.

Note If lost the channel engaged signal, the following will be displayed and this call will be terminated.
"No signal detected in the Work CH."

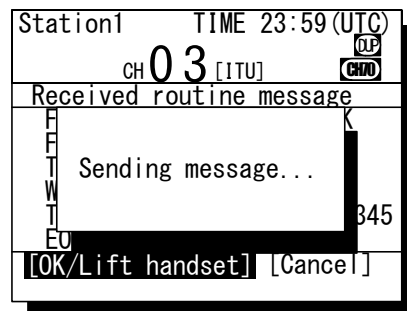

8. The PSTN connection will be completed.

Lift the handset from the cradle and wait for the recipient answering the phone (the PSTN dial tone and ring tone from the handset will be heard at this time). After answered the phone, the phone call charge will be started.

Note If not answered within 1 minute, the following will be displayed and this call will be terminated. (In the case of bad radio link condition, this may also be appeared during communication.)
"Lost the radio receiving signal."

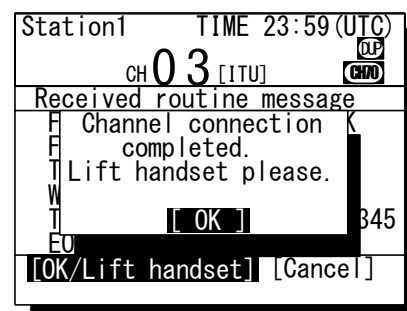

9. When finished the phone call, return the handset to the cradle.

Then an end of call containing the duration will be received from the coast station. The example at right shows 13 minutes and 45 seconds.

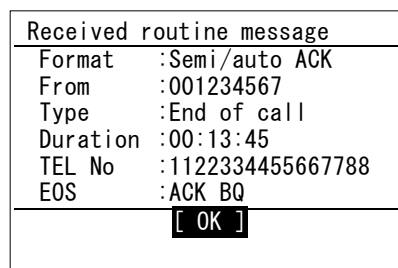

Note

- In the case of the duplex mode of the JHS-780D, the radiotelephone will always be in sending condition. Nevertheless, pressing PTT key is needed to talk.
- According to the coast station, a negative acknowledgement mentioned above may be received at step 7.
- If the negative acknowledgement indicates "unable to comply" with "Queue" reason, the wait mode can be selected. This mode enables to continue the above procedure from step 7 after receiving the ring back call. (However, if receiving no call within 15 minutes after receiving "Queue", the ring back mode is canceled. Also when the **CH16** key is pressed, the ring back mode is canceled.)

(2) Receiving a call from a PSTN subscriber

■ Procedure ■

1. The screen at right will be displayed, and the alarm will sound.

The example message contains the following information.

- Format: Semi/auto call
- Caller's MMSI: 001222333
- Type: Radiotelephone
- Work Channel: CH03
- Caller TEL No: 00123459425

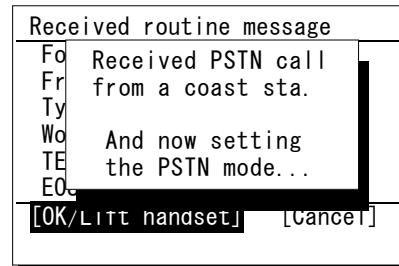

2. After displayed the message as shown at right, lift the handset from the cradle.

- If not answered within 1 minute, the PSTN call will be cancelled.
- After lifting the handset or pressing ENT, a start of call will be sent. If lost the channel engaged signal, the following will be displayed and the PSTN call will be terminated.
"No signal detected in the Work-CH."
- If interrupted the receiving signal for 5 seconds during communication, the following will be displayed and the PSTN call will be terminated.
"Lost the radio receiving signal."

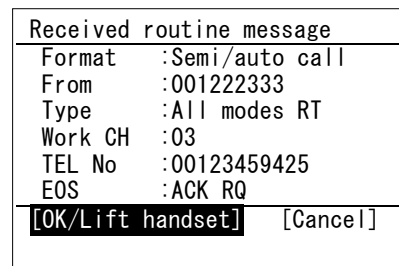

3. When finished the phone call, return the handset to the cradle.

Then an end of call will be received from the coast station. However, the duration of the call will not be displayed for free of charge.

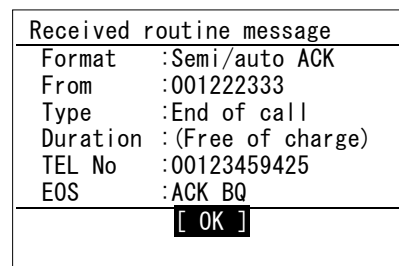

Note

In the case of the duplex mode of the JHS-780D, the radiotelephone will always be in sending condition. Nevertheless, pressing PTT key is needed to talk.

4.3.5 AIS-linked DSC calls

The AIS information (nearby ships call signs, names and identification numbers) will be displayed as "Other ships list", and are available to call a listed ship via the DSC directly.

NOTE: To use this function, set the import condition to ON in the menu 9.6 AIS function.

■ Procedure ■

1. Press **FUNC** → **0AIS**

- 5.1 Other ships list at right will be displayed.
- On the bottom line, the name and MMSI of the ship highlighted by the cursor will be displayed.
- The bearings (BRG) are based on the North-up.
- If 5.2 Proximity check is ON, and the registered ship on the 9.4.2 Ship station list is displayed, **v** mark will be added on the ship's line.
- If existing no ships in the vicinity, "No data" will be displayed on the middle of the screen.

Note The column(s) of the call sign, name or MMSI will be blank when any of these has not been entered to the ship's AIS, or when not receiving the static information at the AIS of own ship.

5.1)Other ships list 01/11	
BRG : RNG	Call sign
10° : 0.9NM	JRCAAA
90° : 1.2NM	JRCBBB
45° : 1.3NM	JRC CCC
359° : 2.0NM	JRCDDD v
221° : 8.3NM	JRCEEE
Name: Pacific JRC	
MMSI: 112233445	

2. Select a ship to call and press ENT using the jog dial.

The popup screen at right will be displayed.

Note If the ship's MMSI has not been displayed, this function will be disabled.

5.1)Other ships list 01/11	
BRG	VESSEL CALL PROCESS
10	Select call type.
90	[Routine] [Safety]
45	[Urgency] [Cancel]
359	
221	
Name: Pacific JRC	
MMSI: 112233445	

3. Select a call type (category) and press ENT using the jog dial.

The individual call menu for the selected category will be displayed.

Note The example screen at right will show the working channel input line for a routine call, but for urgency calls to a ship, inputting the working channel is not needed (fixed to CH16).

1.2)Ship station call	
Address :	[112233445]
Work CH :	[]
[OK] [Cancel]	

4. Press ENT and input the working channel.

- Note**
- The free channel will be searched and displayed automatically.
 - If required, input another channel manually using the **CANCEL** key, the jog dial or the numeric keys.
 - If there is no free channel, a blank will be shown as a search result.

1.2)Ship station call	
Address :	[112233445]
Work CH :	[06]
[OK] [Cancel]	

Operation

5. Press ENT.

Confirm the entered contents.

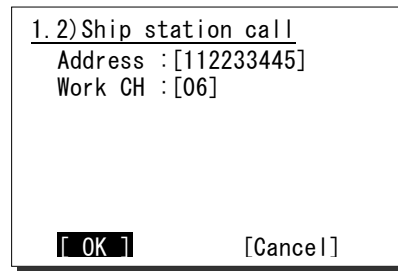

6. If the contents are correct, press ENT.

The sending confirmation screen will appear.

Note The controller displays by default only the edited information in the call setup as shown at right.

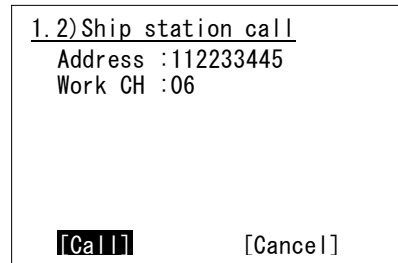

7. Press ENT to transmit the call.

After completed the transmission, the popup screen shown at right will be displayed to wait the acknowledgement.

Note If received no response for 5 minutes, the screen will return to the step 5 mentioned above.

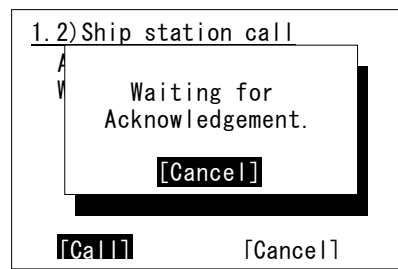

8. When received the acknowledgement, the screen shows the message with the alarm for 3 sec. Then changes to the proposed working channel automatically.

Note

- If 9.5.2 Automatic CH shift is OFF, lifting the handset or pressing ENT is required to set the proposed working channel.
- If an improper channel is proposed, resend the call containing a new channel via the specified new channel proposal form screen.

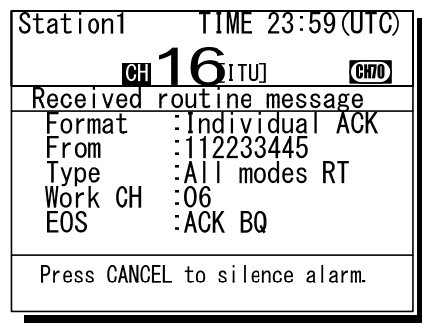

9. The ship station call will be completed after displayed the working channel as shown at right.

Start communications using the handset.

- The example at right shows when proposed CH06 as a working channel.
- When completed the communications, return the handset to the cradle.

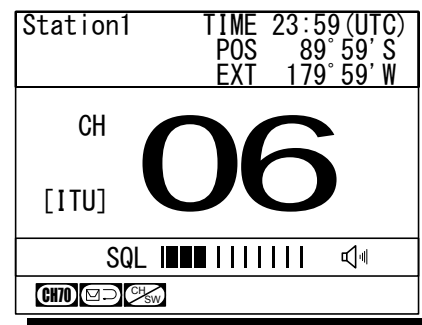

Note If the ship station is unable to comply with the call, as with coast stations, own station (caller) may receive a negative acknowledgement mentioned above section. In this case, if possible according to the message, wait and retry the calling again later.

4.4 Emergency calls (DSC safety/ urgency/ distress calls)

In emergency, the DSC is available for safety/ urgency/ or distress calls. For safety and urgency calls, either individual or all ships is selectable for the type of call. For distress calls, enabled to send either after selecting the nature of distress or without selecting it. In both cases, when own ship is in distress, pressing the dedicated distress key for 4seconds is required to send the distress call.

4.4.1 Safety calls

4.4.1.1 All ships calls

When broadcasting to all ships regarding safety, the all ships call is available.

■ Procedure ■

1. Press the **MENU** key, and through hierarchical menus, select the 2.1.1 All ships.

The working channel inputting form will be displayed. Normally the CH16 by default is used.

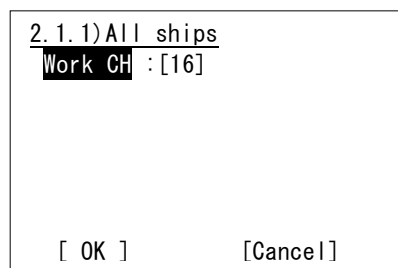

2. Select OK with the jog dial.

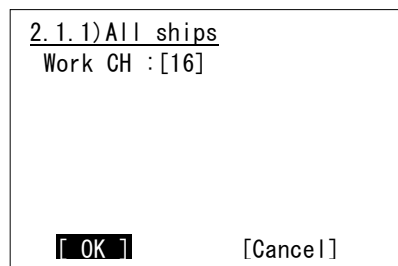

3. Press ENT.

The sending confirmation screen will appear.

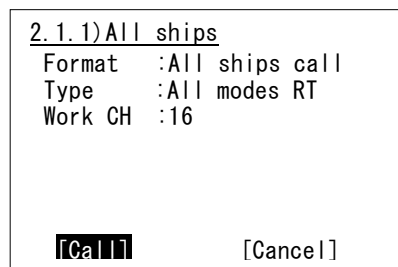

4. Press ENT to transmit the call.

All ships call needs no response and will be completed after displayed the popup screen as shown at right. Lifting the handset or pressing ENT erases the popup screen, and enables to start the communication.

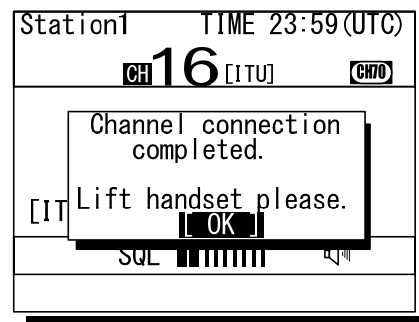

Operation

5. Start the safety broadcasting using the handset.

When completed the communications, return the handset to the cradle.

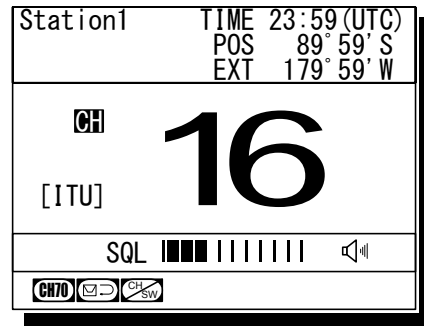

4.4.1.2 Individual calls (All modes RT)

When sending the safety individual call to a ship or coast station, note the difference described below from the case of routine.

- The menu is common for both ship and coast station.
- Other than the address and the working channel, the type is needed to select.
- Normally the CH16 by default is used.

■ Procedure ■

1. Press the **MENU** key, and through hierarchical menus, select the 2.1.2 Specific station.

The menu shown at right will be displayed. If entered previously, the address will be appeared as a default value

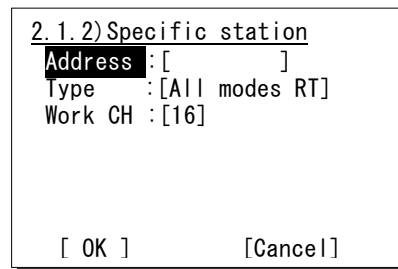

2. Press ENT to display the station list, and select the desired station with the jog dial.

The procedure is similar to that of routine calls, except that the list shows together ship stations and coast stations.

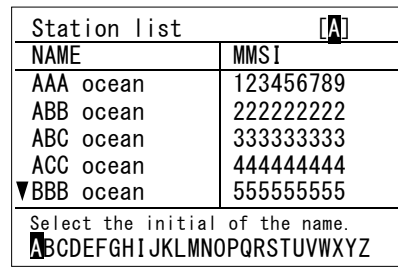

- Note**
- The list can be registered in the menu 9.4 Contact list.
 - When inputting the MMSI manually, press the **CANCEL** key to return to the previous screen and input it using the numeric keypad.

3. Press ENT.

The cursor will move to the Type.

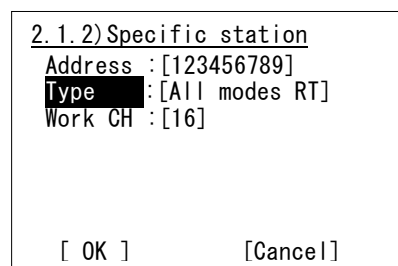

- Press ENT and select a type of call with the jog dial. If intending to voice communication after the call, leave it as "All modes RT", and move the cursor to Work CH.

The following types are selectable.

- All modes RT (for Radiotelephone)
- Position RQ (Position request)
- Test (Safety test)

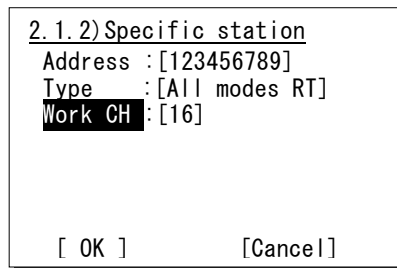

- Normally, use CH16 for the communication of safety and move the cursor to OK with the jog dial.

If required to change the working channel, press ENT and input the channel at the step 4.

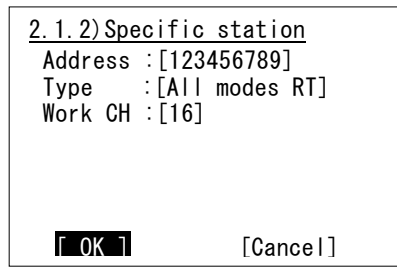

- If the contents are correct, press ENT.

The sending confirmation screen will appear.

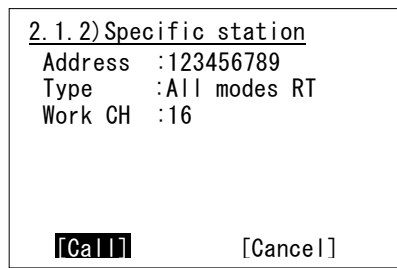

- Press ENT to transmit the call.

After completed the transmission, the popup screen shown at right will be displayed to wait the acknowledgement.

Note If received no response for 5 minutes, the screen will return to the step 5 mentioned above.

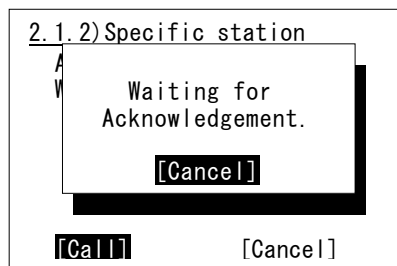

- When received the acknowledgement, the screen shows the message with the alarm for 3 sec. Then changes to the proposed working channel automatically.

Note

- If 9.5.2 Automatic CH shift is OFF, lifting the handset or pressing ENT is required to set the proposed working channel.
- If an improper channel is proposed, resend the call after inputting a new channel proposal.

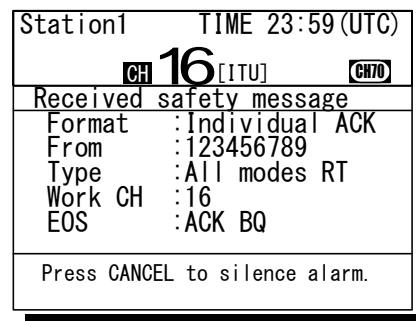

Operation

9. The call will be completed after displayed the working channel as shown at right. Start communications using the handset.

- The example at right shows when proposed CH16 as a working channel.
- When completed the communications, return the handset to the cradle.

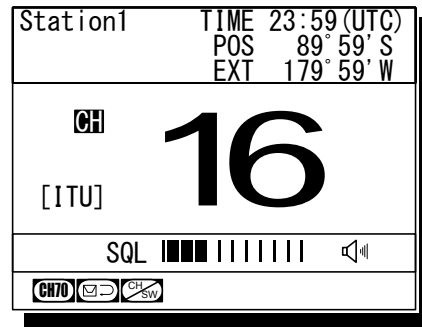

Note

If the called station is unable to comply with the call, as with routine calls, own station (caller) may receive a negative acknowledgement mentioned above section. In this case, if possible according to the message, wait and retry the calling again later.

4.4.1.3 Other features of the safety call (Position request/ Test)

Additional features of safety call, such as a ship position request call or a DSC test call are available. In these cases, there is no voice communication and not needed to set a working channel.

However, the procedures are otherwise identical to those mentioned above, so describes below after completed the editing steps.

(1) Position request call

■ Procedure ■

1. After inputting the ship's address and type (Position RQ), the sending confirmation screen will appear.

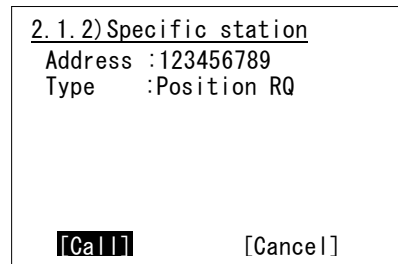

2. Press ENT to transmit the call.

After completed the transmission, the popup screen shown at right will be displayed to wait the acknowledgement.

Note

If received no response for 5 minutes, the screen will return to the editing screen.

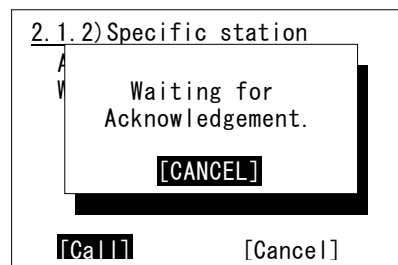

- When received the acknowledgement, the screen shows the message with the alarm as shown at right.

Pressing CANCEL stops alarm and after that, pressing ENT returns to the status display.

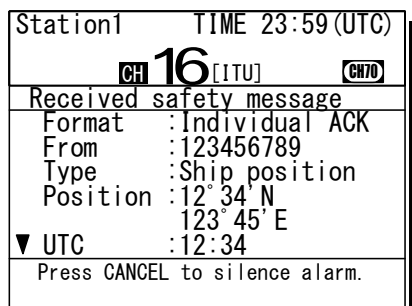

(2) Test call

■ Procedure ■

- After inputting the ship's address and type (Test), the sending confirmation screen will appear.

Note The test call is also available in menu 3. DSC test call, by entering the station address only.

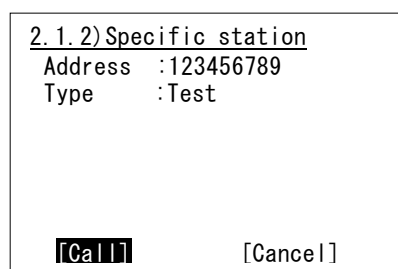

- Press ENT to transmit the call.

After completed the transmission, the popup screen shown at right will be displayed to wait the acknowledgement.

Note If received no response for 5 minutes, the screen will return to the step 1 mentioned above.

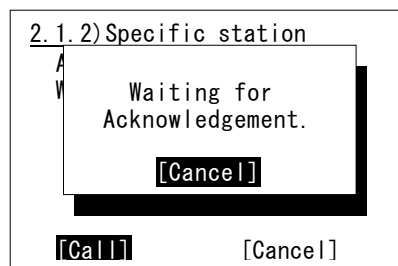

- When received the acknowledgement, the screen shows the message with the alarm as shown at right.

Pressing CANCEL stops alarm and after that, pressing ENT returns to the status display.

Note According to the condition of the station, the acknowledgement may not be received even if the equipment works normally.

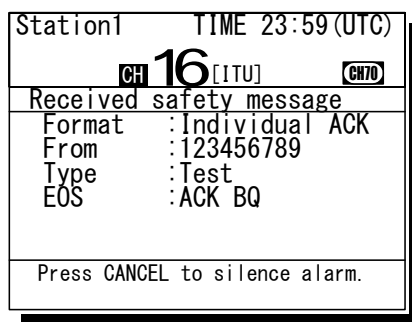

4.4.1.4 Receiving a safety call

When receiving a safety call from a coast station or another ship station, the message will be displayed immediately. Then treat the message according to the type as below.

(1) Receiving an all ships call

■ Procedure ■

1. The screen at right will be displayed, and the alarm will sound.

The example message contains the following information.

- Format: All ships call
- Caller's MMSI: 111222333
- Type: All modes Radiotelephone
- Work Channel: CH16
- EOS: End of sequence.

Received safety message	
Format	:All ships call
From	:111222333
Type	:All modes RT
Work CH	:16
EOS	:EOS
Press CANCEL to silence alarm.	

2. Press the **CANCEL** key to stop the alarm and display the screen at right.

Received safety message	
Format	:All ships call
From	:111222333
Type	:All modes RT
Work CH	:16
EOS	:EOS
[OK/Listen]	[Cancel]

3. If possible to listen to the broadcast, press ENT to set the working channel.

When finished the broadcast used except for the CH16, press the **CH16** key to return to the status display.

Note If Automatic CH shift is ON, the working channel will be changed automatically and the above step 2 and 3 are omitted.

Station1	TIME 23:59(UTC)
	POS 89° 59' S
	EXT 179° 59' W
CH	16
[ITU]	
SQL	■■■■■■■■■■
CH16	

(2) Receiving an individual call (Type: Radiotelephone)

This procedure is identical to the case of a routine call. However the screen shown at right will be displayed with the alarm.

Received safety message	
Format	:Individual call
From	:111222333
Type	:All modes RT
Work CH	:16
EOS	:ACK RQ
Press CANCEL to silence alarm.	

(3) Receiving an individual call (Type: Position request)

■ Procedure ■

1. The screen at right will be displayed, and the alarm will sound.

The example message contains the following information.

- Format: Individual call
- Caller's MMSI: 111222333
- Type: Position request
- EOS: ACK is requested.

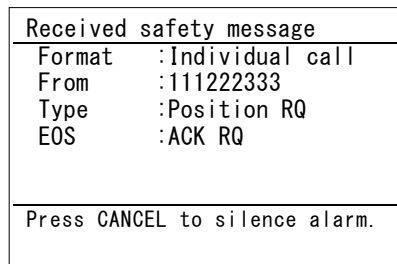

2. Press the **CANCEL** key to stop the alarm and display the screen at right. If possible to respond immediately, press ENT.

- Note**
- If Automatic ACK is ON, the acknowledgement will be sent automatically without notice.
 - If having no position information (unconnected to GPS and elapsed over 23.5 hours after inputting manually), the message editing screen will be displayed after selecting the OK/ACK.

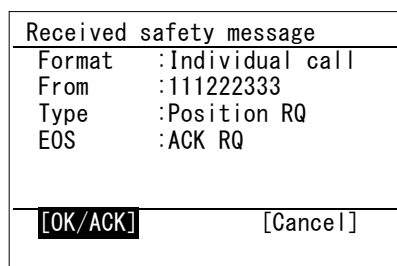

(4) Receiving an individual call (Type: Test)

■ Procedure ■

1. The screen at right will be displayed, and the alarm will sound.

The example message contains the following information.

- Format: Individual call
- Caller's MMSI: 111222333
- Type: Test
- EOS: ACK is requested.

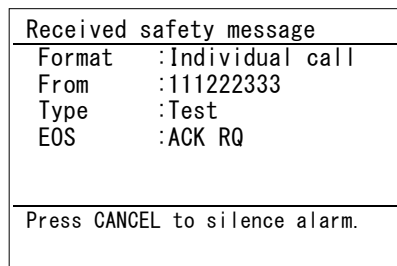

2. Press the **CANCEL** key to stop the alarm and display the screen at right. If possible to respond immediately, press ENT.

- Note**
- If Automatic ACK is ON, the acknowledgement will be sent automatically without notice.

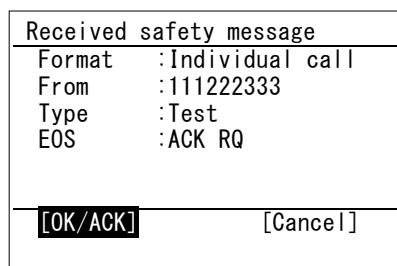

4.4.2 Urgency calls

4.4.2.1 All ships calls

When broadcasting to all ships regarding urgency, the all ships call is available.

■ Procedure ■

1. Press the **MENU** key, and through hierarchical menus, select 2.2.1 All ships.

Normally, this call uses a fixed message, and the sending confirmation screen will appear immediately.

Note Regarding calls for medical transport and neutral ships, additional procedures are required. See 4.4.2.3 for details.

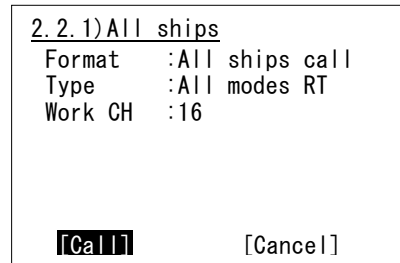

2. Press ENT to transmit the call.

All ships call needs no response and will be completed after displayed the popup screen as shown at right. Lifting the handset or pressing ENT erases the popup screen, and enables to start the communication.

Note If the handset has been left in the off-hook condition in advance, skip to step 3 below without showing the popup screen at right.

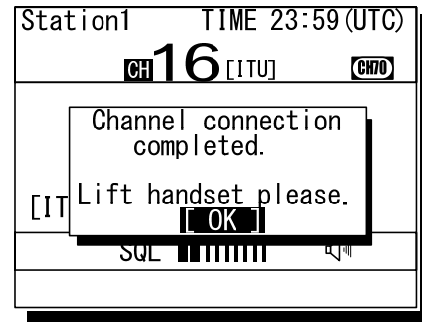

3. Start the urgency broadcasting using the handset.

When completed the communications, return the handset to the cradle.

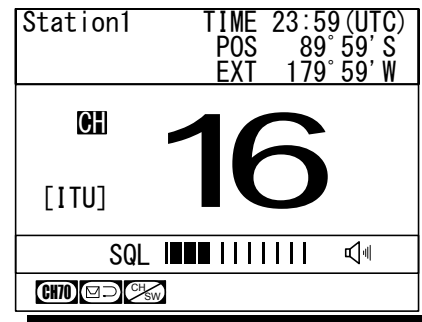

4.4.2.2 Individual calls

When sending the urgency individual call to a ship or coast station, the procedures are basically as described below.

- The menu is common for both ship and coast station.
- Only required to input the address.
- The working channel is fixed on CH16.

■ Procedure ■

1. Press the **MENU** key, and through hierarchical menus, select the 2.2.2 Specific station.

The menu shown at right will be displayed. If entered previously, the address will be appeared as a default value

2.2.2) Specific station	
Address :	[]
[OK]	[Cancel]

2. Press ENT to display the station list, and select the desired station with the jog dial.

This procedure is identical to the case of the safety call.

Station list		[A]
NAME	MMSI	
AAA ocean	123456789	
ABB ocean	222222222	
ABC ocean	333333333	
ACC ocean	444444444	
▼BBB ocean	555555555	
Select the initial of the name.		
ABCDEFGHIJKLMN OPQRSTUVWXYZ		

3. Press ENT.

Confirm the address.

2.2.2) Specific station	
Address :	[123456789]
[OK]	[Cancel]

4. If the contents are correct, press ENT.

The sending confirmation screen will appear.

2.2.2) Specific station	
Address :	123456789
[Call]	[Cancel]

Operation

5. Press ENT to transmit the call.

After completed the transmission, the popup screen shown at right will be displayed to wait the acknowledgement.

Note If received no response for 5 minutes, the screen will return to the step 3 mentioned above.

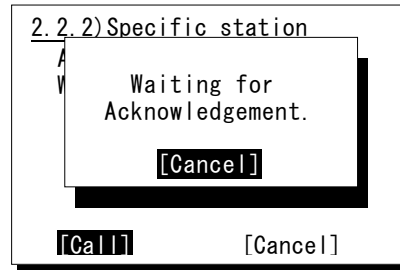

6. When received the acknowledgement, the screen shows the message with the alarm for 3 sec. Then changes to the working channel (CH16) automatically.

Note - If 9.5.2 Automatic CH shift is OFF, lifting the handset or pressing ENT is required to set the working channel.
 - The specific alarm for urgency sounds and notifies the receiving of the acknowledgement.

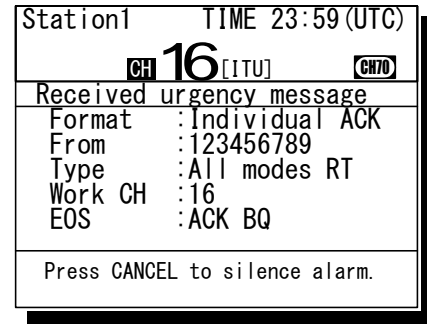

7. The station call will be completed after displayed the working channel as shown at right.
 Start communications using the handset.

When completed the communications, return the handset to the cradle.

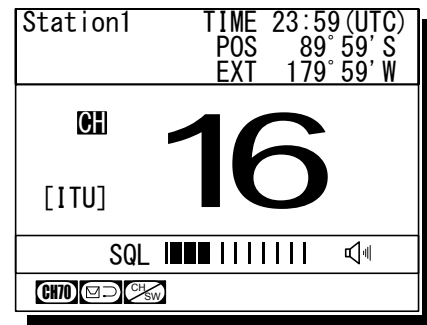

Note If the called ship or coast station is unable to comply with the call, own station (caller) may receive a negative acknowledgement with the reason mentioned above. In this case, if possible according to the message, wait and retry the calling again later.

4.4.2.3 Special calls (Medical transport/ Neutral ship)

When sailing dangerous waters such as political instability, the urgency all ships call containing the additional subject is available to inform others of the following information concerned.

- Own ship is performing medical transportation and protected under the 1949 Geneva Convention.
- Own ship is of neutral nationality.

■ Procedure ■

1. Set the 9.5.4 Medical/Neutral use to ON, before this call operation.

- Note**
- This setting is always reset to the default value (OFF) after powering off/on.
 - Receiving these calls are always possible regardless of the setting.

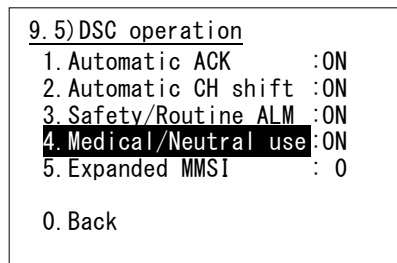

2. Press the **MENU** key, and through hierarchical menus, select 2.2.1 All ships.

The subject selection form for urgency all ships call will be displayed.

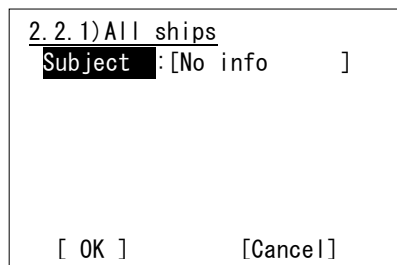

3. Press ENT and select the subject to be added to the call message with the jog dial.

Select a subject from below.

- No info (for No information)
- Medical TRNSP (for Medical transport)
- Neutral ship (for Neutral nationality)

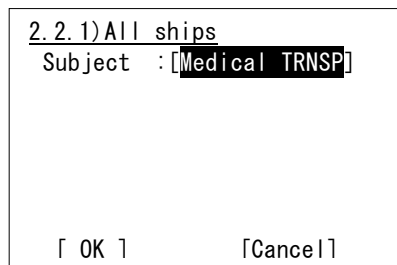

4. Press ENT.

The cursor will move to OK.

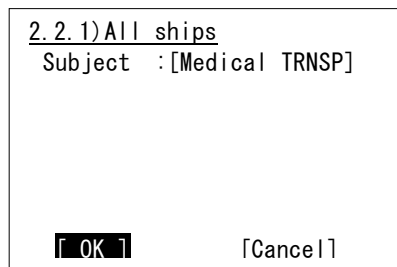

5. If the content is correct, press ENT.

The sending confirmation screen will appear.

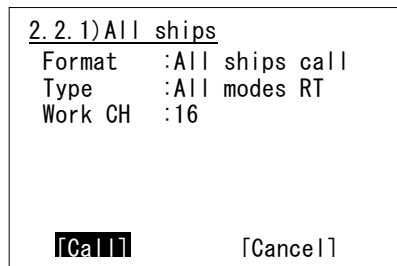

Operation

6. Press ENT to transmit the call.

All ships call needs no response and will be completed after displayed the popup screen as shown at right. Lifting the handset or pressing ENT erases the popup screen, and enables to start the communication.

Note

If the handset has been left in the off-hook condition in advance, skip to step 7 below without showing the popup screen at right.

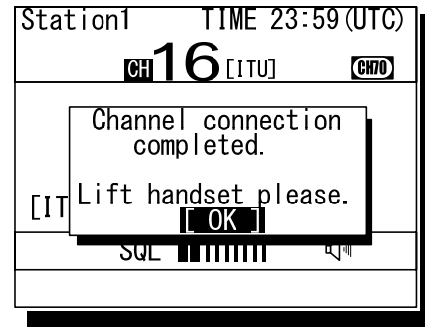

7. Start the urgency broadcasting using the handset.

When completed the communications, return the handset to the cradle.

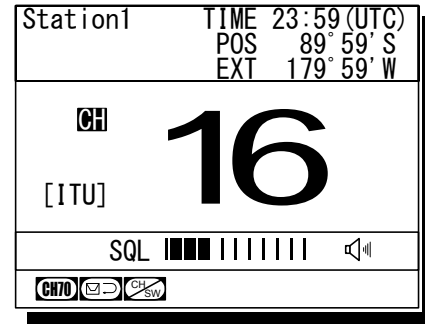

4.4.2.4 Receiving an urgency call

When receiving an urgency call from a coast or another ship station, the message will be displayed immediately with the specific alarm for urgency calls. Then treat the message according to the type as below.

(1) Receiving an all ships call

■ Procedure ■

1. The screen at right will be displayed, and the alarm will sound growing louder gradually.

The example message contains the following information.

- Format: All ships call
- Caller's MMSI: 111222333
- Type: All modes radiotelephone
- Work Channel: CH16
- EOS: End of sequence.

Note

When containing additional information regarding Medical TRNSP or Neutral ship, the Subject line will be added.

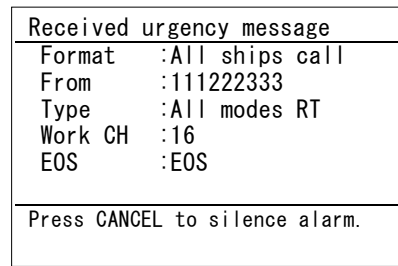

2. Press the **CANCEL** key to stop the alarm, and display the screen at right.

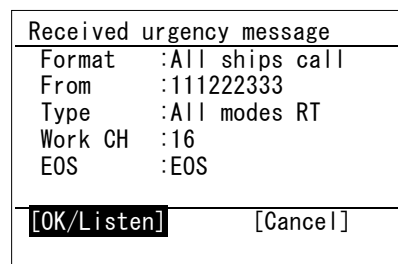

3. If possible to listen to the broadcast, press ENT to set the working channel.

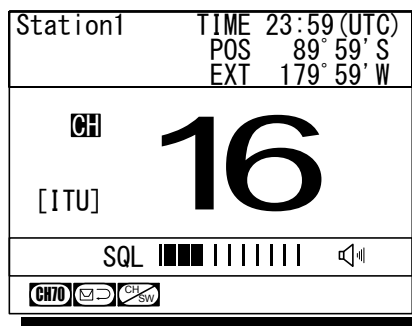

Note If receiving the call containing the information regarding the medical transport or the neutral ship, the message will show it as the "Subject".

(2) Receiving an Individual Call

■ Procedure ■

1. The screen at right will be displayed, and the alarm will sound growing louder gradually.

The example message contains the following information.

- Format: Individual call
- Caller's MMSI: 111222333
- Type: All modes radiotelephone
- Work channel: CH16
- EOS: ACK is requested.

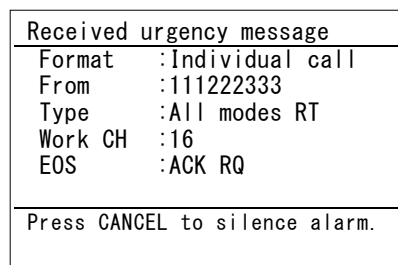

2. Press the **CANCEL** key to stop the alarm and display the screen at right.

Note This step is omissible.

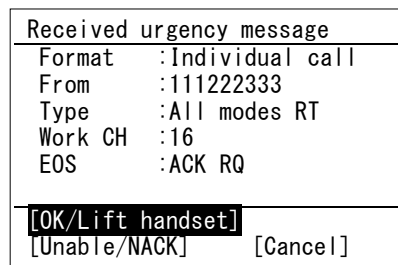

3. If possible to communicate immediately, lift the handset from the cradle and start the communications.

- In this example case, enabled to select the response from below with the jog dial.
 - OK/Lift handset: Starts communications immediately.
 - Unable/NACK : Sends "Unable to comply" message with that reason.
 - Cancel : Returns to the status display without handling this message.
- When completed the communications, return the handset to the cradle.

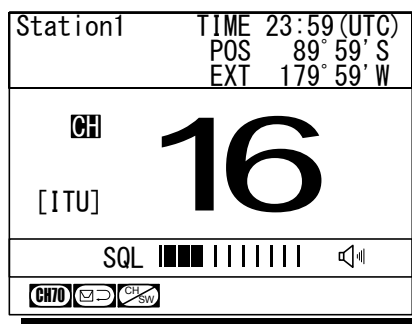

4.4.3 Distress calls (Distress alerts)

When in distress, distress calls are always transmitted by pressing the dedicated **DISTRESS** key. The distress calls transmit own MMSI, ships position, time of the position, and the nature of distress.

CAUTION



Do not test the distress call as doing so will inconvenience local shipping and Rescue Centers.



When sending a distress call, follow the instructions of the ship's captain or officer in charge.



If a false distress call is transmitted accidentally, follow the instructions below:

1. Press the **CANCEL** key on the controller (when appropriate, follow the commands on screen) and terminate the transmission of the distress call.
2. Report the false distress call to a nearby RCC (Rescue Coordination Center).
(In Japan, inform the nearest Japan Coast Guard.)
Information to be reported:
The date/time, location, and reason why the false call was transmitted.
Also report the ship's name, type, nationality, ID number as well as the unit model name and manufacture number/date, if possible.
3. Report the false distress call to nearby ships using CH16.
4. If any acknowledgements to the distress call are received, inform the ships of the false distress call.

4.4.3.1 Quick distress calls

The following describes the procedure to send a distress call immediately without using menus. In this case, the nature of distress in the message will be sent as "Undesignated" by default. Further, if no information for the position and the time of position obtained within 23.5 hours, these information will be composed automatically as "9999999999" and "8888" respectively.

■ Procedure ■

1. Open the **DISTRESS** key cover.



2. Press and hold the **DISTRESS** key for 4 seconds until the countdown is completed.

If released before the countdown is completed, displays the menu of 2.3 Distress call for the nature of distress selection.

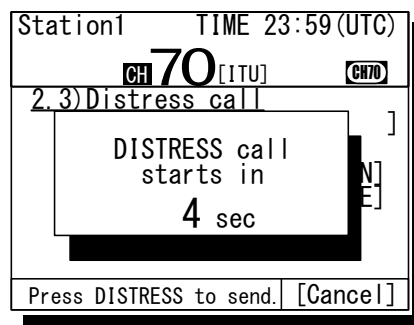

3. The distress call will be sent.

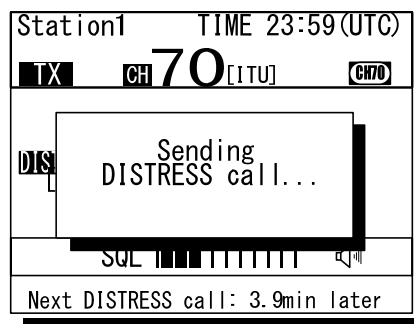

4. Automatically remained in distress mode until received the acknowledgement.
 - The distress call will be automatically repeated every 3.5 - 4.5 minutes until received the acknowledgement or manually breaks the mode. (The bottom line indicates the remaining time until the next distress call.)
 - The distress call can be sent as many times as needed in this condition by the **DISTRESS** key operation mentioned above.

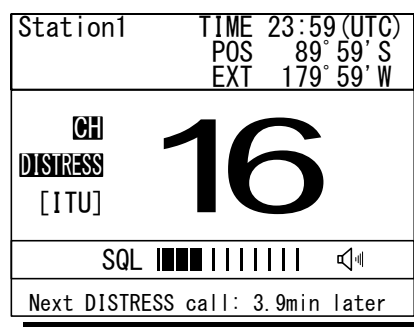

5. When acknowledged, the screen at right will be displayed and the alarm will sound growing louder gradually. Then lift the handset and request rescue using CH16 of the radiotelephone.

- The ALM lamp blinks in sync with the alarm sound.
- Only to silence the alarm, press the **CANCEL** key when displaying the screen at right.
- First, the responding station will call on the CH16, then acknowledge the receipt as follows.
 - "MAYDAY",
 - "this is",
 - Own ship's MMSI and call sign, position, nature of distress, and rescue requests

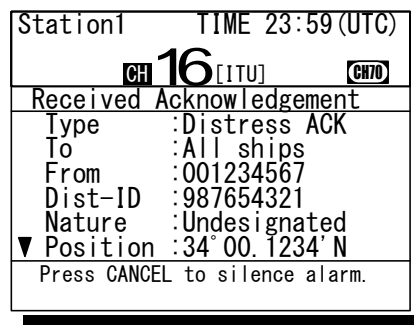

Note The following popup screens will be displayed as appropriate in distress mode.

Popup message	Contents	Notes
Attention!/Restarting distress call soon...	Notifies that the distress call will be resent within 12 seconds.	
Received other call. Break DISTRESS mode to view message?	Equipment received a call but not the acknowledgement.	To continue distress mode, select [Continue], or to cancel distress mode to check the received DSC call, select [Break]
Now continuing DISTRESS call mode. Break this mode?	Confirmation screen when pressed the CANCEL key in distress mode	To continue distress mode, select [Continue], or to cancel distress mode, select [Break]

4.4.3.2 Distress calls from the menu

The following describes the procedure to send a distress call with the nature of distress selected in the menu. Also, if there is no valid information regarding the position and the time of position, the manual input is available in that menu.

■ Procedure ■

1. Press the **MENU** key, and through hierarchical menus, select the 2.3 Distress call.

Indicates "Undesignated" as the nature of distress by default, and the position information if obtained from a GPS automatically or entered manually.

```

2.3)Distress call
Nature : [Undesignated ]
Position: [NE]
          [ 12° 34. 5678' N]
          [123° 45. 6789' E]
UTC      : [12:20]

Press DISTRESS to send. | [Cancel]
    
```

2. Press ENT and select the nature of distress.

The nature of distress is selectable from below.

Nature of distress	Contents
Fire	Fire, explosion
Flooding	Flooding
Collision	Collision
Grounding	Grounding
Listing	Listing, in danger of capsizing
Sinking	Sinking
Disabled	Disabled and adrift
Undesignated	Undesignated distress
Abandoning	Abandoning ship
Piracy attack	Piracy/armed robbery attack
Man overboard	Man overboard

```

2.3)Distress call
Nature : [Undesignated ]
Position: [NE]
          [ 12° 34. 5678' N]
          [123° 45. 6789' E]
UTC      : [12:20]

Press DISTRESS to send. | [Cancel]
    
```

3. Press ENT.

The cursor will move to Position.
If already displayed the valid position and time of position, no entry is necessary and skip to step 7.

```

2.3)Distress call
Nature : [Flooding      ]
Position: [NE]
          [ 12° 34. 5678' N]
          [123° 45. 6789' E]
UTC      : [12:20]

Press DISTRESS to send. | [Cancel]
    
```

4. Press ENT and select the quadrant of the position with the jog dial.

The quadrant will be changed as NE → NW → SE → SW.

```

2.3)Distress call
Nature : [Flooding      ]
Position: [NE]
          [ 12° 34. 5678' N]
          [123° 45. 6789' E]
UTC      : [12:20]

Press DISTRESS to send. | [Cancel]
    
```

5. After pressing ENT, input the latitude and longitude using the numeric keypad.

After registered the every digit, input the UTC.

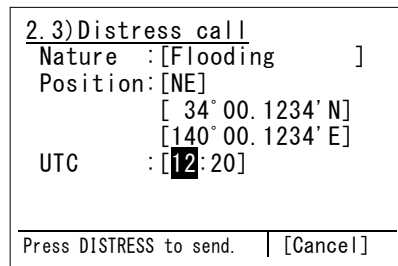

6. After completed the registrations, the cursor will return to Nature.

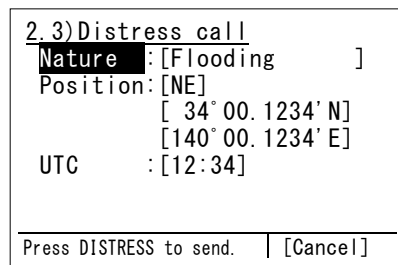

7. Open the **DISTRESS** key cover.



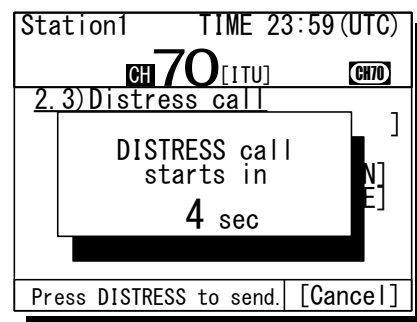

8. Press and hold the **DISTRESS** key for 4 seconds until the countdown is completed.



Note The rest of the procedure is the same as described in the "Quick distress call".

4.4.3.3 Receiving a distress call

When a distress call is received, the message will be immediately displayed with the specific two-tone alarm sound identical to the urgency.

 <h1 style="margin: 0;">WARNING</h1>	
	<p>If a distress call is received, make sure to inform the ship's captain or officer in charge.</p> <p>Doing so may save the lives of the crew and passengers on the ship in distress.</p>

■ Procedure ■

1. When a distress call is received, the distress message will be displayed.

The alarm lamp will blink in sync with the alarm sound, gradually growing louder. The example message contains the following information.

- Type: Distress call
- Caller's MMSI: 431001234
- Nature of distress: Fire, explosion
- Position & the time: North latitude 12° 34.5678'
East longitude 123° 45.6789'
12:14
- EOS: End of sequence
(appears by scrolling)

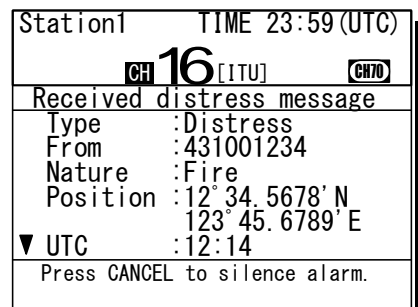

2. Press the **CANCEL** key to stop the alarm, and the screen at right will be displayed.

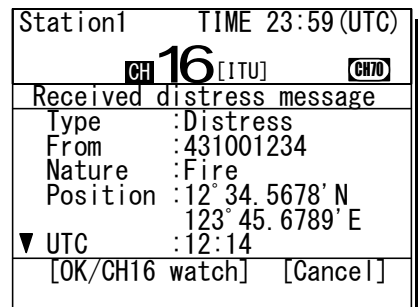

3. Select "OK/CH16 watch" with the jog dial and press ENT to watch on CH16.

Keep watch for at least 5 minutes and, if necessary, notify a coast station or concerned administration.

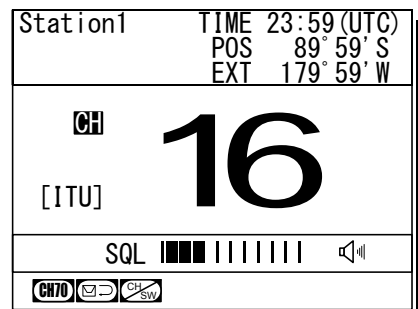

4.4.3.4 Acknowledgement to a received distress call

After receiving a distress call, ship stations have to watch on CH16. But if received the distress call repeatedly, ship stations (inc. own ship) are allowed to transmit a DSC acknowledgement to terminate the call only after consulting with an RCC or a coast station and being directed to do so.

■ Procedure ■

1. Press the **MENU** key, and through hierarchical menus, select the 4.1 Received distress list.

On the bottom line, the MMSI of the ship highlighted by the cursor will be displayed.

4.1) Received distress list	
Date/Time	Type
'06-12-31 11:20	Distress
From: 431012345	

2. Select the call to be acknowledged and press ENT.

The distress message will be displayed.

Received distress message	
Type	:Distress
From	:431012345
Nature	:Fire
Position	:34° 00. 1234' S 140° 00. 1234' W
UTC	:11:20
[Close] [ACK] [Relay]	

3. Select ACK with the jog dial and press ENT.

The popup message at right will be displayed.

Received distress message	
▲ Fr	- Attention ! -
Na	Send this call only
Pc	when being directed
	by administration.
UT	[Continue] [Cancel]
EC	[Close] [ACK] [Relay]

4. After confirmed the popup message, select "Continue" and press ENT to send the acknowledgement.

After the transmission, the channel will be set to 16 automatically.

Note After sending the acknowledgement, commence the distress traffic via radiotelephony on CH16.

- "MAYDAY"
- Repeat the 9-digit identity (MMSI) of the ship in distress, 3 times.
- "this is"
- Repeat own ship's 9-digit identity (MMSI), 3 times.
- ""RECEIVED MAYDAY"

Station1	TIME 23:59 (UTC)
	POS 89° 59' S
	EXT 179° 59' W
CH	16
[ITU]	
SQL	■■■■■■■■■■
CH70	CH SW

4.4.4 Distress relay calls on behalf of someone else (Proxy distress calls)

If another ship is in distress but itself unable to make a distress call, and the master of the ship considers that further help is necessary, the distress relay call on behalf of the ship can be transmitted using "Proxy distress call" menu. In this case, compose a distress relay call format by inputting the MMSI (if known), the ship's position and the time of position (if known), and the nature of distress to send to all ships or a coast station.



CAUTION



When sending a proxy distress call (DROBOSE), do NOT press the **DISTRESS** key. Doing so will inconvenience local shipping and Rescue Centers. (This proxy distress call can be sent via [Call] button displayed on the screen.)

4.4.4.1 All ships calls

Transmits a proxy distress call (DROBOSE) to all ships.

■ Procedure ■

1. Press the **MENU** key, and through hierarchical menus, select 2.4.1 All ships call.

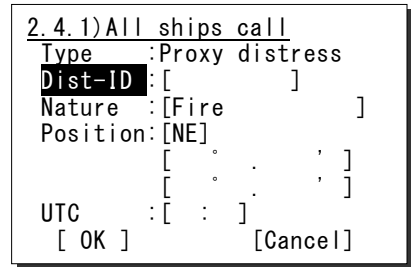

2. If the 9-digit identity (MMSI) of the ship in distress is known, press ENT and input it.

If unknown, move the cursor to Nature with the jog dial and skip to step 4 below.

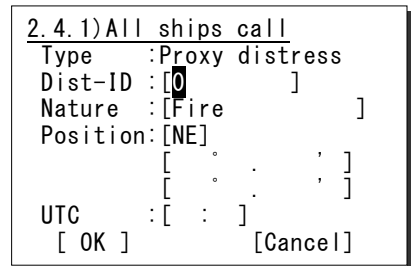

3. Press ENT.

The cursor will move to Nature.

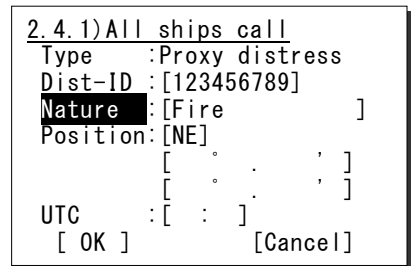

4. Press ENT and select the nature of distress with the jog dial.

The nature of distress is selectable from below.

Nature of distress	Contents
Fire	Fire, explosion
Flooding	Flooding
Collision	Collision
Grounding	Grounding
Listing	Listing, in danger of capsizing
Sinking	Sinking
Disabled	Disabled and adrift
Undesignated	Undesignated distress
Abandoning	Abandoning ship
Piracy attack	Piracy/armed robbery attack
Man overboard	Man overboard
EPIRB emission	Received DSC VHF EPIRB signal

```

2.4.1)All ships call
Type :Proxy distress
Dist-ID :[123456789]
Nature :[Fire ]
Position:[NE]
[ : ]
[ : ]
UTC :[ : ]
[ OK ] [Cancel]
    
```

5. Press ENT.

The cursor will move to Position.

```

2.4.1)All ships call
Type :Proxy distress
Dist-ID :[123456789]
Nature :[Fire ]
Position:[NE]
[ : ]
[ : ]
UTC :[ : ]
[ OK ] [Cancel]
    
```

6. If the position and the time of position of the ship in distress are known, press ENT.

If unknown, move the cursor to OK with the jog dial and skip to step 8 below.

```

2.4.1)All ships call
Type :Proxy distress
Dist-ID :[123456789]
Nature :[Fire ]
Position:[NE]
[ : ]
[ : ]
UTC :[ : ]
[ OK ] [Cancel]
    
```

7. Input the quadrant, latitude, longitude and the time of position, respectively and press ENT.

The cursor will move to OK.

```

2.4.1)All ships call
Type :Proxy distress
Dist-ID :[123456789]
Nature :[Fire ]
Position:[NE]
[ 12° 34. 5678' N]
[ 123° 45. 6789' E]
UTC :[12:20]
[ OK ] [Cancel]
    
```

8. Press ENT.

The sending confirmation screen will appear. Further, unregistered items will be indicated as "Unknown".

```

2.4.1)All ships call
Type :Proxy distress
Dist-ID :123456789
Nature :Fire
Position :12° 34. 5678' N
123° 45. 6789' E
UTC :12:20
[Call] [Cancel]
    
```

Operation

9. Press ENT to transmit the call.

Watch on CH16 and wait for the acknowledgement. After acknowledged, commence the distress traffic regarding the ship in distress.

- Note**
- When acknowledged from a coast station via DSC, the screen at right (lower) will be displayed and the specific alarm will sound growing louder gradually.
 - The ALM lamp blinks in sync with the alarm sound.
 - As a general rule, ship stations are allowed to acknowledge only by the radiotelephone.

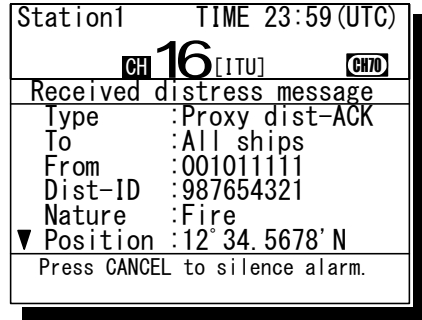
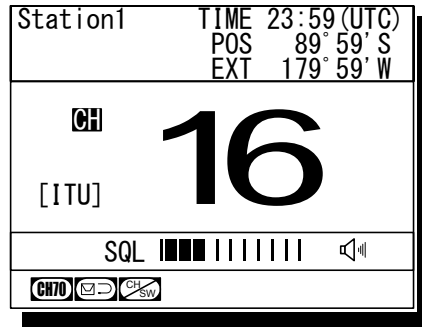

4.4.4.2 Coast station calls

Transmits a proxy distress call (DROBOSE) to a specified coast station.

■ Procedure ■

1. Press the **MENU** key, and through hierarchical menus, select 2.4.2 Coast station call.

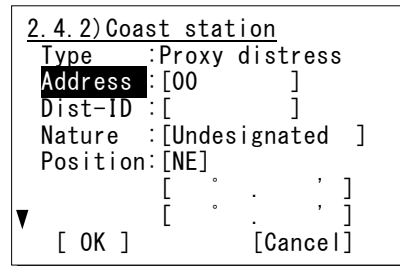

2. Press ENT to display the coast station list, and select the desired station with the jog dial.

The procedure is identical to the case of the routine calls.

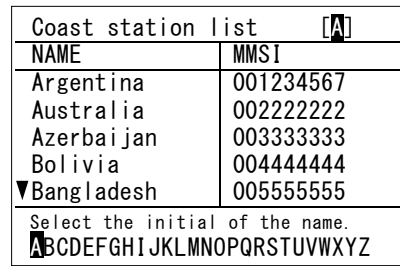

3. Pressing ENT will move the cursor to Dist-ID. If the 9-digit identity (MMSI) of the ship in distress is known, press ENT and input it.

If unknown, move the cursor to Nature with the jog dial and skip to step 5 below.

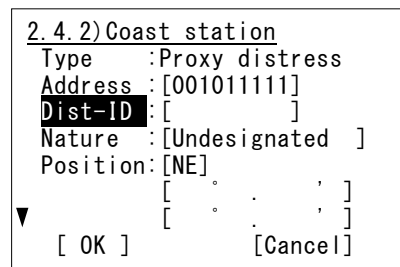

4. Press ENT

The cursor will move to Nature.

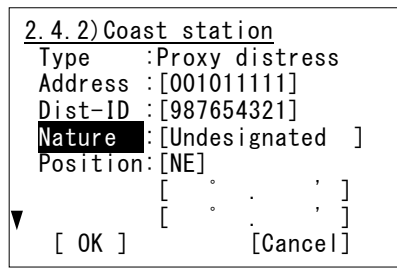

5. Press ENT and select the nature of distress with the jog dial.

The nature of distress is selectable from below.

Nature of distress	Contents
Fire	Fire, explosion
Flooding	Flooding
Collision	Collision
Grounding	Grounding
Listing	Listing, in danger of capsizing
Sinking	Sinking
Disabled	Disabled and adrift
Undesignated	Undesignated distress
Abandoning	Abandoning ship
Piracy attack	Piracy/armed robbery attack
Man overboard	Man overboard
EPIRB emission	Received DSC VHF EPIRB signal

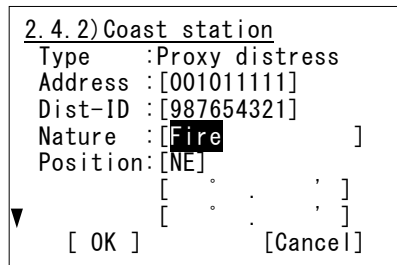

6. Press ENT.

The cursor will move to Position.

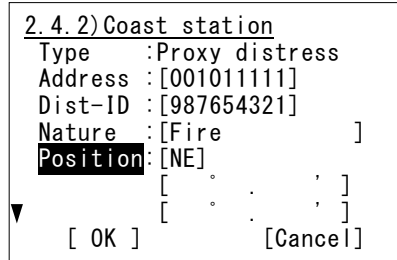

7. If the position and the time of position of the ship in distress are known, press ENT.

If unknown, move the cursor to OK button with the jog dial and skip to step 9 below.

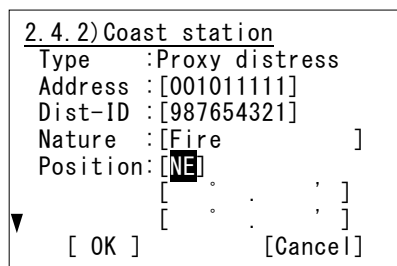

8. Input the quadrant, latitude, longitude and the time of position, respectively and press ENT.

The cursor will move to OK.

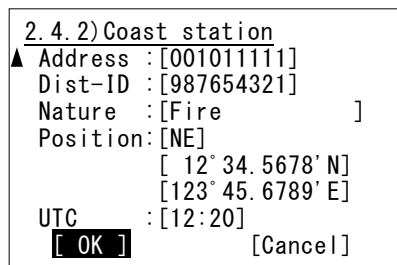

Operation

9. Press ENT.

The sending confirmation screen will appear.
Further, unregistered items will be indicated as "Unknown".

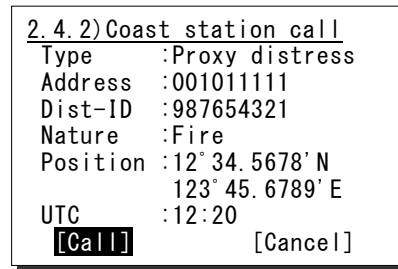

10. Press ENT to transmit the call.

Watch on CH16 and wait for the acknowledgement.

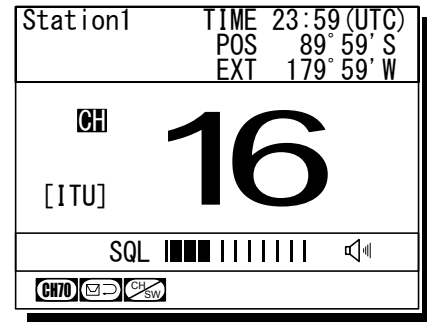

11. When acknowledged, the screen at right will be displayed and the alarm will sound growing louder gradually.

Then lift the handset and commence distress traffic for the ship in distress.

- The ALM lamp blinks in sync with the alarm sound.
- Only to silence the alarm, press the **CANCEL** key when displaying the screen at right.

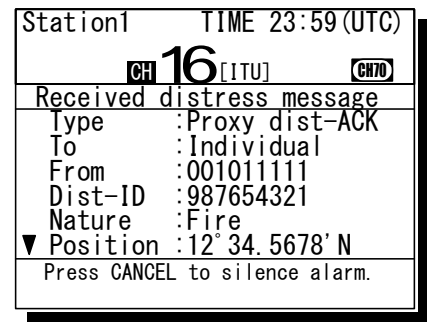

4.4.4.3 Receiving a proxy distress call

When received a distress relay call (DROBOSE) directed to all ships, the ship stations (inc. your own ship) are allowed to acknowledge only by the radiotelephone. (Receiving a distress relay call from a coast station is the same.)

■ Procedure ■

1. When received a proxy distress call, the screen at right will be displayed.

- The specific alarm will sound growing louder gradually.
- The ALM lamp blinks in sync with the alarm sound.
- The example message contains the following information.

- Type: Proxy distress call
- To: All ships
- Caller's MMSI: 123456789
- MMSI of ship in distress: 987654321
- Nature of distress: Fire, explosion
- Position and Time: North latitude 12° 34.5678'
(Longitude and the time appears by scrolling.)
- EOS: ACK is requested.
(appears by scrolling)

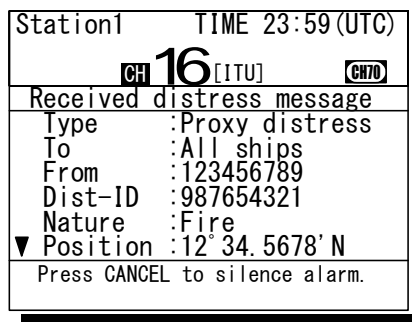

2. Press the **CANCEL** key to stop the alarm, and the screen at right will be displayed.

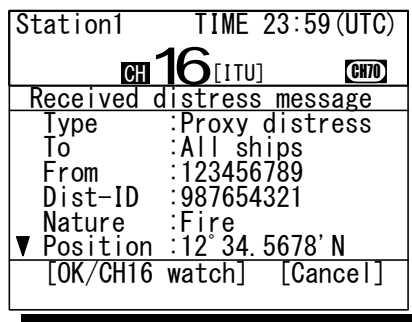

3. Select OK/CH16 watch with the jog dial and press ENT then watch on CH16.

Keep watch for at least 5 minutes and, if necessary, notify a coast station or concerned administration via radiotelephony.

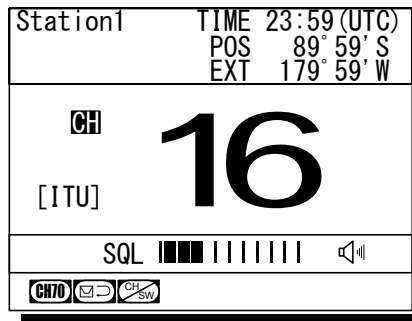

4.4.5 Distress relay calls

After receiving a distress call, ship stations have to watch on CH16 for at least 5 minutes. But if there is no distress traffic on CH16 in the meantime, the distress relay call will be available to inform a coast station of the distress call transmitted by the ship in distress.

4.4.5.1 Sending a distress relay call

A distress relay call can be composed from the log of the received distress message.

■ Procedure ■

1. Press the **MENU** key, and through hierarchical menus, select the 4.1 Received distress list.

On the bottom line, the MMSI of the ship highlighted by the cursor will be displayed.

4.1) Received distress list	
Date/Time	Type
'06-12-31 14:55	Distress
From: 987654321	

2. Select the distress call to be relayed and press ENT.

The distress message will be displayed.

Received distress message	
Type	:Distress
From	:987654321
Nature	:Fire
Position	:34° 00. 1234' N 140° 00. 1234' E
▼ UTC	:14:55
[Close] [ACK] [Relay]	

3. Select Relay with the jog dial and press ENT.

The popup message at right will be displayed.

Received distress message	
▲ Fr	- Attention ! -
Na	Normally, this call
Po	should be sent to
	coast station.
UT	[Continue] [Cancel]
EO	[Close] [ACK] [Relay]

4. After confirmed the popup message, select "Continue" and press ENT.

The address inputting screen will be displayed.

Distress relay call	
Address	: []
[OK] [Cancel]	

5. Press ENT to display the station list of both the coast stations and the ship stations, and select the desired station with the jog dial.

When inputting the MMSI manually, press the **CANCEL** key to return to the previous screen and input it using the numeric keypad.

Station list [A]	
NAME	MMSI
Argentina	001234567
Australia	002222222
Azerbaijan	003333333
Bolivia	004444444
▼ Bangladesh	005555555
Select the initial of the name. ABCDEFGHIJKLMN OPQRSTUVWXYZ	

6. Press ENT.

The cursor will move to OK.

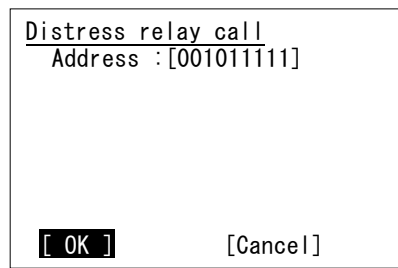

7. Press ENT.

The sending confirmation screen will appear.

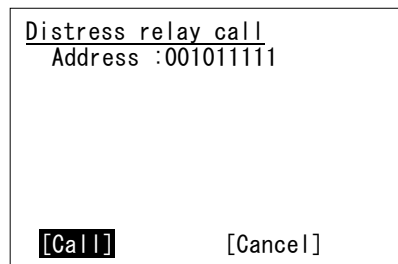

8. Press ENT to send the distress relay call.

After the transmission, the channel will be set to 16 automatically.

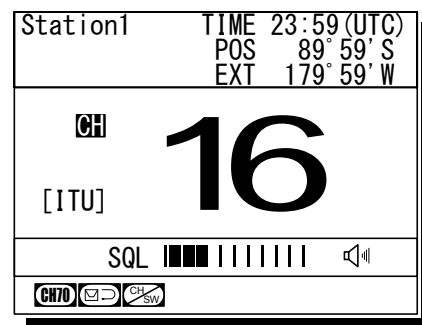

9. When acknowledged, the screen at right will be displayed and the alarm will sound growing louder gradually. Then lift the handset and commence distress traffic for the ship in distress.

- The ALM lamp blinks in sync with the alarm sound.
- Only to silence the alarm, press the **CANCEL** key when displaying the screen at right.

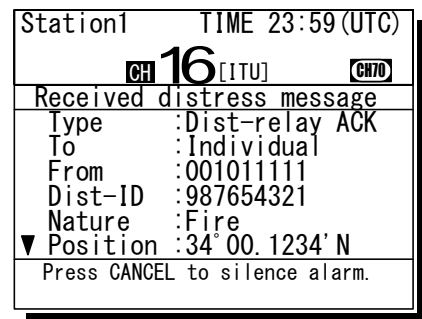

4.4.5.2 Receiving a distress relay call

Normally, ship stations receive a distress relay call in the following situations.

- When a coast station has transmitted an all ships or individual distress relay call.
- When another ship station has transmitted a distress relay call to all ships, an individual distress relay call, or a geographic distress relay call to a specific sea area.

As a general rule, the ship stations should respond via radiotelephony after receiving a distress relay call. But if called individually by another ship station, and if allowed by a coast station, a distress relay acknowledgement can be transmitted as follows. Further, a distress relay acknowledgement can be composed from the log of the received distress relay message.

■ Procedure ■

1. When a distress relay call is received, the screen at right will be displayed.

- The specific alarm will sound growing louder gradually.
- The ALM lamp blinks in sync with the alarm sound.
- The example message contains the following information.

- Type: Distress relay call
- To: Individual (own ship)
- Caller's MMSI: 123456789
- MMSI of ship in Distress: 987654321
- Nature of distress: Fire, explosion
- Position and Time: North latitude 34° 00.1234'
(Longitude and the time appears by scrolling.)
- EOS: ACK is requested.
(appears by scrolling)

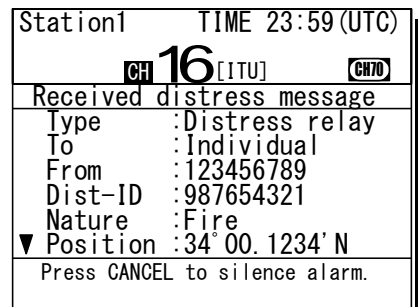

2. Press the **CANCEL** key to stop the alarm, and the screen at right will be displayed.

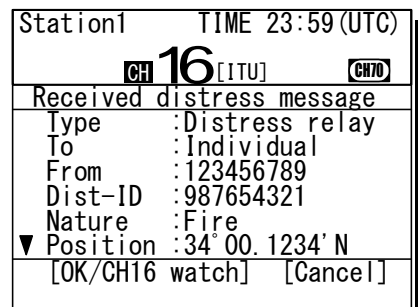

3. Select OK/CH16 watch with the jog dial and press ENT then watch on CH16.

- Keep watch for at least 5 minutes.
- When acknowledging the distress relay, follow the procedure described below.

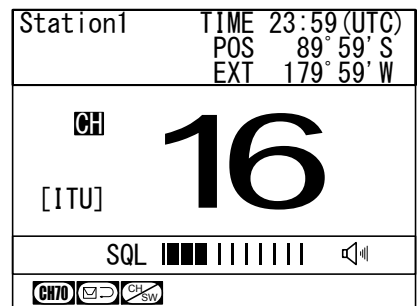

- Press the **MENU** key, and through hierarchical menus, select the 4.1 Received distress list.

On the bottom line, the MMSI of the ship highlighted by the cursor will be displayed.

4.1) Received distress list	
Date/Time	Type
'06-01-10 08:45	Relay
From: 123456789	

- Select the distress relay call to be acknowledged and press ENT.

The distress relay message will be displayed.

Received distress message	
Type	:Distress relay
To	:Individual
From	:123456789
Dist-ID	:987654321
Nature	:Fire
▼ Position	:34° 00. 1234' N
[Close]	[ACK]

- Select ACK with the jog dial, and press ENT.

The popup message at right will be displayed.

Received distress message	
▲ Di	- Attention ! -
Na	Send this call only
Po	when being directed
	by administration.
UT	[Continue] [Cancel]
EO	
[Close]	[ACK]

- After confirmed the popup message, select "Continue" and press ENT to send the distress relay acknowledgement.

After the transmission, the channel will be set to 16 automatically. Then wait for a call via radiotelephony on that channel.

Station1	TIME 23:59 (UTC)
	POS 89° 59' S
	EXT 179° 59' W
CH	16
[ITU]	
SQL	■■■■■■■■■■ ■■■■■■
CH70	CH SW

4.5 Simple DSC test call

The following describes simple procedure to send a DSC test call from the dedicated menu.

(Note: This menu is prepared to simplify the test call procedure in the menu 2.1.2 Specific station, and both of the message formats are exactly the same.)

■ Procedure ■

1. Press the **MENU** key, and through hierarchical menus, select the 3. DSC test call.

The address inputting screen will be displayed. If entered previously, the address will be appeared as a default value.

3) DSC test call
Address : [123456789]
 [OK] [Cancel]

2. Input the desired station's MMSI and press ENT.

The procedure is identical to the case of an individual call for safety. (The list shows ship stations first, and then coast stations.)

3) DSC test call
 Address : [123456789]
 [OK] [Cancel]

3. If the contents are correct, press ENT.

The sending confirmation screen will appear.

3) DSC test call
 Address : 123456789
 [Call] [Cancel]

4. Press ENT to transmit the call.

After completed the transmission, the popup screen shown at right will be displayed to wait the acknowledgement.

Note

If received no response for 5 minutes, the screen will return to the step 1 mentioned above.

3) DSC test call
 Waiting for Acknowledgement.
 [Cancel]
 [Call] [Cancel]

5. When received the acknowledgement, the screen shows the message with the alarm as shown at right.

Pressing CANCEL stops alarm and after that, pressing ENT returns to the status display.

Note

According to the condition of the station, the acknowledgement may not be received even if the equipment works normally.

Station1	TIME 23:59 (UTC)
CH 16 [ITU]	CH70
Received safety message	
Format	: Individual ACK
From	: 123456789
Type	: Test
EOS	: ACK BQ
Press CANCEL to silence alarm.	

4.6 DSC call log

Received DSC messages are classified as distress messages and as other messages. The 20 most recent messages for both types of received and transmitted are saved in the log.

⚠ CAUTION



A distress acknowledgement or a distress relay call can be transmitted from a received distress message stored in the log, but when sending such a kind of call, follow the instructions of the ship's captain or officer in charge.



Received distress calls are automatically deleted after 48 hours to avoid accidental resending or other misoperation. Accordingly, if such messages cannot be read out, it is not a malfunction.

4.6.1 Received distress messages

Received messages regarding distress calls and the acknowledgements, distress relay calls and the acknowledgements will be displayed in this received distress message log. Additionally, when receiving a distress call containing the same 5 messages, only one of those will be stored.

■ Procedure ■

1. Press the **MENU** key, and through hierarchical menus, select the 4.1 Received distress list.

- On the bottom line, the MMSI of the ship highlighted by the cursor will be displayed.
- In the event of a receiving error (ECC error), "ECC error" will be indicated in the Type field.

4.1) Received distress list	
Date/Time	Type
'06-12-31 11:20	ACK
'06-12-31 11:15	Relay-ACK
'06-12-31 11:10	Distress
'06-12-30 08:55	Relay
From: 431012345	

2. To view a message, select a line by timestamp and/or message type, and press ENT.

The selected message will be displayed.

Also the screen shows Message handling menus at the bottom of the screen and enabled to handle the message as follows.

(The handling menus will differ depending on the type of message .)

- Close: Close the message and return to the list.
- ACK: Send the acknowledgement to the caller. (In this case, to the ship in distress)
- Relay: Send this message to a specified coast station as a distress relay call.

Received distress message	
Type	:Distress
From	:987654321
Nature	:Fire
Position	:34° 00. 1234' S 140° 00. 1234' W
▼ UTC	:14:55
[Close] [ACK] [Relay]	

4.6.2 Received other messages

Received messages regarding routine, safety, and urgency calls or the acknowledgements will be displayed in this received other message log.

■ Procedure ■

1. Press the **MENU** key, and through hierarchical menus, select the 4.2 Received others list.

- On the bottom line, the MMSI of the ship highlighted by the cursor will be displayed.
- In the event of a receiving error (ECC error), "ERR" will be indicated in the CAT field.
(Note: CAT: category, FMT: format)

4.2) Received others list			
Date/Time	CAT	FMT	
'06-11-23 15:30	RTN	INDIV	
'06-11-20 22:15	URG	ACK	
'06-11-19 07:10	SAF	ALL	
'06-11-15 18:33	RTN	GRP	
From: 123456789			

2. To view a message, select a line by timestamp, category and/or format, and press ENT.

The selected message will be displayed.

Also the screen shows Message handling menus at the bottom of the screen and enabled to handle the message as follows.

(The handling menus will differ depending on the type of message .)

- Close: Close the message and return to the list.
- ACK: Send the acknowledgement to the caller.
- NACK: Send a negative acknowledgement with the reason to the caller.
- New CH: Send the acknowledgement with another working channel proposal.
- MMSI: Register the caller's ID.
(The corresponding menu such as 9.4.1 Coast station list will be opened.)
- TEL No: Register the PSTN caller's or recipient's telephone number.
(Menu 9.4.4 PSTN number list will be opened.)

Received routine message			
Format	:Individual call		
From	:123456789		
Type	:All modes RT		
Work CH	:10		
EOS	:ACK RQ		
[Close]	[ACK]	[NACK]	
[New CH]	[MMSI]		

4.6.3 Transmitted messages

Every transmitted message will be displayed in this transmitted message log.

■ Procedure ■

1. Press the **MENU** key, and through hierarchical menus, select the 4.3 Transmitted calls list.

On the bottom line, the address information (such as MMSI) of the line highlighted by the cursor will be displayed.

4.3) Transmitted calls list		
Date/Time	CAT	FMT
'06-01-23 12:30	RTN	INDIV
'06-12-15 20:15	URG	ACK
'06-12-13 18:10	SAF	ALL
'06-11-20 06:33	RTN	GRP
'06-11-18 08:45	RTN	INDIV
To: 123456789		

2. To view a message, select a line by timestamp, category and/or format, and press ENT.

The selected message will be displayed.

Also the screen shows Message handling menus at the bottom of the screen and enabled to handle the message as follows.

(The handling menus will differ depending on the type of message .)

Transmitted routine message	
Format	: Individual call
To	: 123456789
Type	: All modes RT
Work CH	: 10
<p>[Close] [Resend] [Edit&Send]</p>	

- Close: Close the message and return to the list.
- Resend: Resend this message to the same address.
- Edit&Send: Make a new call after revising based on the message.

4.7 Other features

In addition to the features described above, the equipment contains useful some features as below.

4.7.1 Notification of registered ships by the AIS

If the AIS have been installed and set to available by the following procedure (and the menu 9.6 AIS function), when ships registered in the contact list falls within the specified range, a popup screen will be displayed immediately and notifies the ship's information by the name or 9-digit identity (MMSI).

■ Procedure ■

1. Press the **MENU** key, and through hierarchical menus, select the 5. AIS information.

Note The example at right shows the factory default setting.

2. To activate this function, select the line of 2. Rgst ships check, and after pressing ENT, set the condition to ON with the jog dial.

3. Press ENT.

If changing the proximity range, after pressing ENT again, input the appropriate value within the range of 0.1 to 99.9NM with the numeric keypad or jog dial.

4. After completed the proximity range setting, the cursor will move to the 0. Back.

Note When detected the registered ship within the specified proximity range, the popup screen as shown at right will be appeared immediately.

However, if the AIS information does not contain the ship's name, the name line will be replaced by the MMSI number.

```
5)AIS information
1.Other ships list
2.Proximity check :OFF
  tip)Notify of when listed-ship
  fall within the range.
3.Proximity range :20.0NM
0.Back
```

```
5)AIS information
1.Other ships list
2.Proximity check :ON
  tip)Notify of when listed-ship
  fall within the range.
3.Proximity range :20.0NM
0.Back
```

```
5)AIS information
1.Other ships list
2.Proximity check :OFF
  tip)Notify of when listed-ship
  fall within the range.
3.Proximity range :20.0NM
0.Back
```

```
5)AIS information
1.Other ships list
2.Proximity check :OFF
  tip)Notify of when listed-ship
  fall within the range.
3.Proximity range :20.0NM
0.Back
```

```
Station1      TIME 23:59(UTC)
CH16 [ITU]    CH70
- AIS information -
Detected this ship
in the vicinity.
[ITU] JRC Marine OCNT23456 [OK]
SQL [|||||]
```

4.7.2 Playback of received voice

When opened the squelch, incoming voice will be automatically recorded (up to 120 seconds), and can be replayed to confirm voice communications. Recorded voice is divided into multiple tracks depending on the time for the squelch open/close, and will remain stored until power off. If the total recorded time of all tracks reaches 120 seconds, recorded tracks will be overwritten beginning with the oldest one.

(1) Replay and stop operations

■ Procedure ■

1. Press **FUNC** → **9**

- If existing any recorded tracks, replay the latest track immediately.
- Pressing ENT will reset the counter and restart the playback of the track.
- The example at right shows the following.
 - Replying track number: 001
 - Total track numbers: 012
 - Counter value (elapsed time): 002 seconds
 - Recorded time of the track: 035 seconds

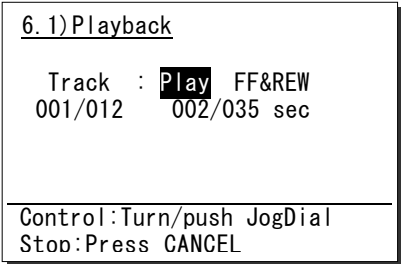

2. After finished the playback of the latest track, the cursor will automatically move to **Track** and the function will enter stop mode.

- To stop the playback manually, press the **CANCEL** key.
- If existing other tracks recorded, enabled to select a track number with the jog dial in stop mode.
- To replay beginning with the displayed track to the latest one, press ENT in stop mode.
- To finish this menu, press the **CANCEL** key in stop mode.

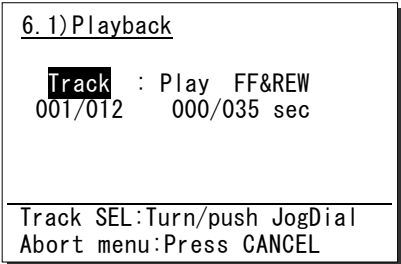

(2) Fast forward and rewind operations

During playback, the fast forward or rewind is available by the following procedure.

■ Procedure ■

1. Rotate the jog dial during playback to move the cursor to FF&REW.

- Rotating the jog dial right will perform fast forward by increasing the counter value.
- Rotating the jog dial left will perform rewind by decreasing the counter value.
- To break FF&REW operation, press the **CANCEL** key. After that, the playback will resume from when playback was paused.

```
6.1)Playback
Track : Play FF&REW
001/012 002/008 sec
-----
Control:Turn/push JogDial
Stop:Press CANCEL
```

2. After FF&REW operation, press ENT to continue to replay from the counter position.

Further, after 1sec elapsed since the FF&REW operation, the playback will resume automatically without pressing ENT.

```
6.1)Playback
Track : Play FF&REW
001/012 002/020 sec
-----
Control:Turn/push JogDial
Stop:Press CANCEL
```

(3) Temporary track saving

Normally, when the total recorded time of all tracks reaches 120 seconds, new voice track will overwrite beginning with the oldest track. But if desired to save a track until power off, perform the procedure below.

■ Procedure ■

1. When the cursor is on **Track** (stop mode), select the desired track with the jog dial.

The example at right shows the case of track 1 selected.

Note Only 1 track can be saved.

```
6.1)Playback
Track : Play FF&REW
001/012 000/035 sec
-----
Track SEL:Turn/push JogDial
Abort menu:Press CANCEL
```

2. Press ENT for more than 1 second.

- When completed the saving, a beep will sound and the track number will change from "001" to "S", as is shown at right.
- The saved track is registered as the last number. In the example at right, the track is saved as No.12.

```
6.1)Playback
Track : Play FF&REW
S /012 000/035 sec
Saved the track as #012.
-----
Track SEL:Turn/push JogDial
Abort menu:Press CANCEL
```

Note When completed the saving, the subsequent track numbers will be shifted down by 1.

(4) The saved track deletion

To delete a saved track, perform the following procedure. (Powering off will delete all tracks.)

■ Procedure ■

1. When the cursor is on **Track** (stop mode), select DEL with the jog dial.

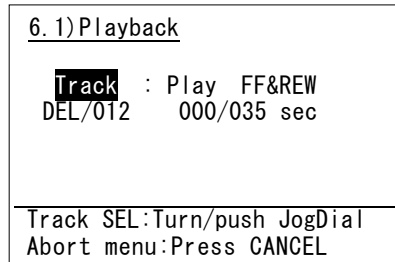

2. Press ENT.

A confirmation message will appear.

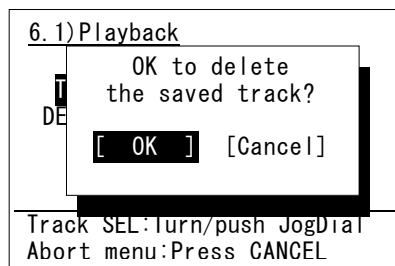

3. After confirmed the popup message, select "OK" and press ENT.

After completed the deletion, track 1 will be selected, as shown at right.

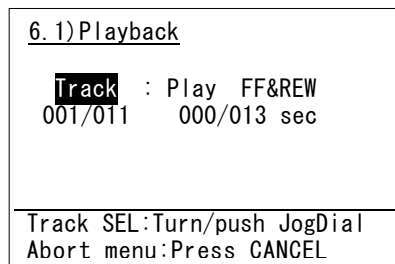

4.7.3 Public Address function with an external speaker (option)

If an external speaker (NVS-423R) is connected, the Public Address function is available to make an announcement over the external speaker.

■ Procedure ■

1. Lift the handset from the cradle, and press **FUNC** → **4PA**.
 - The equipment will immediately enter PA mode and enabled to make an announcement over the external speaker.
 - Press PTT key to talk.
 - To finish the public address function and return to the status display, place the handset back on hook.
(Also, pressing the **CANCEL** key is as well.)

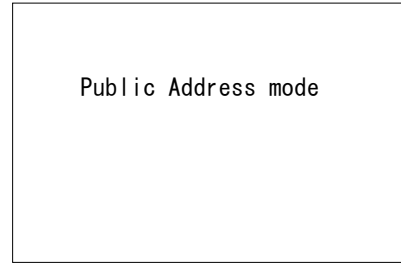

Note

In this mode, radio wave is not transmitted by PTT.

4.7.4 Intercom

If multiple controllers (NCM-1770) are connected, the intercom is available between two of them.

(1) Calling another controller

■ Procedure ■

1. Lift the handset from the cradle, and press **FUNC** → **5^{INT}COM**.

- The controller list will be displayed.
- The example at right shows that the following controllers are connected.
 - Address 1: Station1
 - Address 2: Calling controller
 - Address 3: Station3
 - Address 4: Station4
 (Address 5 controller is not connected.)

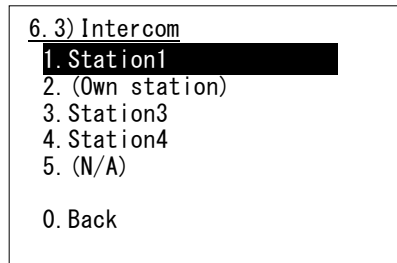

2. Select a recipient with the jog dial and press ENT.

- The screen at right will be displayed and the intercom call will start.
- To cancel the calling, press the **CANCEL** key or hang up the handset while calling.

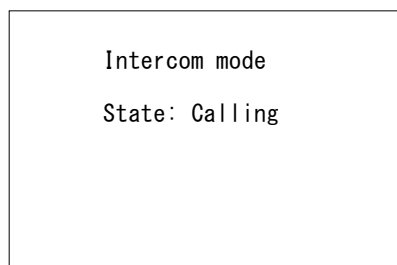

Note

- If the handset of the recipient has been left in the off-hook condition, the call will not start, and the screen shown at right will be displayed. Then press ENT to return to the step 1.

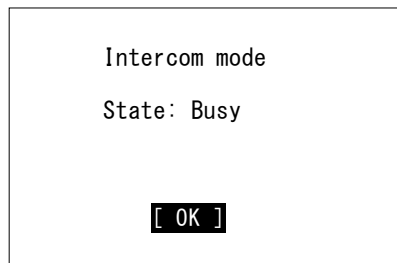

- If not answered within 30 seconds, the screen shown at right will be displayed. Then press ENT to return to the step 1.

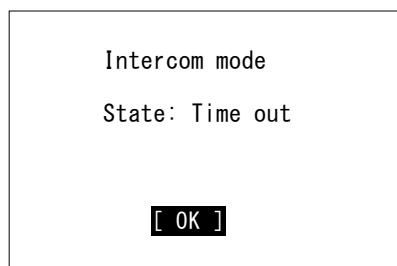

3. After answered the phone, the screen shown at right will be displayed and enabled to start the communication.

- Press PTT key to talk.
- To finish the intercom, place the handset back on hook.

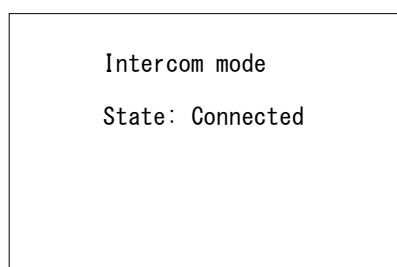

(2) Receiving a call from another controller

■ Procedure ■

1. If received an intercom call, the screen at right will be displayed, and the ringing tone will sound.

If not answer within 30 seconds, the screen will revert to the previous screen.

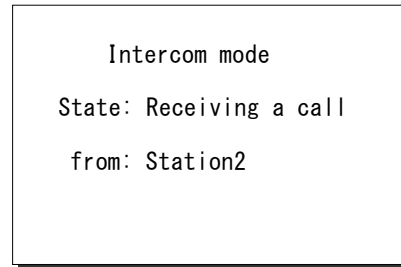

Intercom mode
State: Receiving a call
from: Station2

2. When answering to the call, lift the handset and start the communication.

- Press PTT key to talk.
- To finish the intercom, place the handset back on hook.

Note

- The **OCC** mark will remain displayed even while talking, because the called controller (recipient) is in monitor mode.
- While using the intercom function between two of controllers, if the other controllers are connected, those screens will display as shown at right.

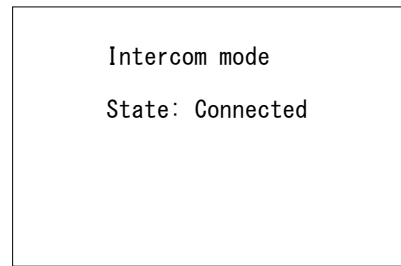

Intercom mode
State: Connected

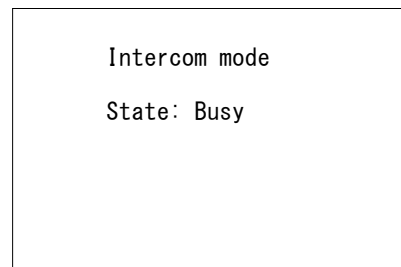

Intercom mode
State: Busy

4.8 Popup screens

The contents of the popup screens are as follows. (in alphabetical order)

Message	Buttons	Description
Acknowledged! Accept it and abort this menu immediately?	Accept/ Ignore	Received a DSC acknowledgement (ACK BQ) during menu operation. Accept: Closes the menu and shows the message immediately. Ignore: Closes this popup only.
Acknowledged! From: xxxxxxxx Shifting CH now...	-----	Received a PSTN acknowledgement from the coast station (MMSI: xxxxxxxx), and the transceiver is shifting to the specified work channel now.
AIS information Detected this ship in the vicinity. MMSI: xxxxxxxx	OK	Detected the ship (MMSI: xxxxxxxx) in the AIS information within the specified sea area.
AIS information Detected this ship in the vicinity. xxxxxxxxxxxxxxxxxxxx	OK	Detected the ship (named xxxxxxxxxxxxxxxxxxxx) in the AIS information within the specified sea area.
Attention! DSC usage is NOT allowed on Inland Waterways.	Continue/ Cancel	DSC usage is NOT allowed on Inland Waterways. Continue: Enforces the DSC operation. Cancel: Ceases the DSC operation.
Attention! Specified a duplex channel used for a coast station comm.	Continue/ Cancel	When calling a ship or a group by the DSC, specified a duplex channel as a work channel, which is used for a coast station communication. Continue: Enforces the operation. Cancel: Ceases the operation.
Attention! Normally, this call should be sent to a coast station.	Continue/ Cancel	When sending a distress relay call, it should be normally addressed to a coast station. Continue: Continues the operation. Cancel: Ceases the operation.
Attention! Restarting distress call soon...	-----	DSC resends the distress call automatically soon.
Attention! Send this call only when being directed by administration.	Continue/ Cancel	To send the distress acknowledgement or the distress relay acknowledgement, the consulting with RCC or a coast station is necessary. Continue: Continues the operation. Cancel: Ceases the operation.
Channel connection completed. Lift handset please.	-----	The channel connection via the DSC has been completed. Please start the communication using the handset.
Channel dial op is invalid right now. To enable it, press FUNC, and ENT.	-----	The channel operation with the jog dial is disabled right now. To enable it, press the FUNC key and ENT in order.
CHxx SQL Setting Register or erase the SQL level?	REG/ Erase	Register or erase the preset squelch level of the xx channel. REG: Registers the current level. Erase: Erases the preset condition.

Operation

Coast sta no answer.	OK	After the PSTN call, there is no answer from the coast station.
Confirming channel free...	Cancel	To send the DSC call (routine calls or test), confirming if the CH70 is free, or waiting until the CH70 becomes free.
Data updating...	-----	Updating the AIS information.
DISTRESS call starts in Xsec	-----	Detected keeping the DISTRESS key held down, and the distress call will be sent in X seconds.
DISTRESS pressed by xxxxxxxxxx and starts in Xsec	-----	The DISTRESS key of xxxxxxxxxx has been held down now, and the distress call will be sent in X seconds.
Erase all data?	OK/ Cancel	Is it ok to erase every station data of this station list? OK: Erases all data. Cancel: Ceases this operation.
Erase this number?	OK/ Cancel	Is it ok to erase this station data? OK: Erases this station data. Cancel: Ceases this operation.
Invalid address	OK	The DSC calling address is empty or invalid.
Invalid TEL number	OK	The recipient telephone number for a PSTN call is empty or invalid.
Invalid value	OK	An invalid value is detected during a process of a task.
Invalid work CH	OK	The work channel data for the DSC call is empty or invalid.
Is it OK to break PSTN mode?	OK/ Cancel	Pressed the CANCEL key during PSTN communication mode. Is it ok to break? OK: Breaks the PSTN mode. Cancel: Continues the PSTN mode.
Left without operating... This process will be canceled soon.	-----	This process will be canceled in 1 min and returns to the status display condition because the controller has been left for 9 min without operating.
Lost the radio receiving signal.	OK	Lost the carrier receiving at the work channel during the PSTN mode, and breaks the communication.
No signal detected in the Work-CH.	OK	The transceiver shifted to the specified work channel to start the PSTN communication, but cannot detect the carrier from the coast station.
Now continuing DISTRESS call mode. Break this mode?	Continue/ Break	Pressed the CANCEL key during the distress call mode. Is it ok to break? Continue: Continues the distress mode. Break: Breaks the distress mode.
OK to "sleep" this no access right controller?	Sleep/ Cancel	Pressed the DIM + PWR keys at this controller without the access rights. Is it ok to enter the sleep mode? Sleep: Enters the sleep mode. Cancel: Ceases this operation.

OK to clear SQL of all xxx CH?	OK/ Cancel	Is it ok to clear every preset squelch data of the xxx channel mode? OK: Erases all preset SQL data. Cancel: Ceases this operation.
OK to delete the saved track?	OK/ Cancel	Is it ok to delete the saved track where the recorded voice has been saved temporarily? OK: Deletes the saved track. Cancel: Ceases this operation.
OK to overwrite?	OK/ Cancel	Is it ok to overwrite the caller's MMSI on the specified line number where another station has been registered? OK: Overwrites it on the line. Cancel: Ceases this operation.
OK to power off the VHF system?	OK/ Sleep/ Cancel	Pressed the DIM + PWR keys at this controller with the access right. OK: Turns off the power. Sleep: Enters the sleep mode. Cancel: Ceases this operation.
Press ENT to stop the sound.	-----	Testing the internal loudspeaker now. After checking the sound, press ENT to stop it.
Print out this data?	OK/ Cancel	Print out the displaying data? OK: Prints out now. Cancel: Ceases this operation.
Printing now...	Cancel	Printing out the displaying data. Wait a moment.
Received DISTRESS. Accept it and abort this menu immediately?	Accept/ Ignore	Received the DSC distress call during menu operation. Is it ok to abort the current process to view the message? Accept: Breaks the current process to view the distress message. Ignore: Closes the popup only.
Received DSC call. Accept it and abort this menu immediately?	Accept/ Ignore	Received the DSC call during menu operation. Is it ok to abort the current process to view the message? Accept: Breaks the current process to view the DSC message. Ignore: Closes the popup only.
Received other call. Break DISTRESS mode to view message?	Continue/ Break	Received the DSC call during distress mode. Break this mode to view the message now? Continue: Continues the distress mode. Break: Breaks the distress mode.
Received PSTN call from a coast sta. And now setting the PSTN mode...	-----	Received a PSTN call from a coast station and setting the PSTN mode. Wait a moment.
Remaining the field maintenance mode. Please restart after maintenance.	OK	Equipment is left in the field maintenance mode. Please restart.
Required to input position & time. Accept it now?	Accept/ Ignore	The external position fixing device (ex. GPS) is not valid and required to input position & time manually. Abort the current menu now? Accept: Abort and input them now. Ignore: Closes the popup only.
Ring backed! From: xxxxxxxxx Shifting CH now...	-----	Received a PSTN ring back call from a coast station and now setting the PSTN mode. Wait a moment.
Sending DISTRESS call...	-----	Sending the distress call now.
Sending message...	-----	Sending the DSC message now.

Operation

Stopped transmitting by 5minutes timer. Release & repress the PTT, please.	OK	The transmission has continued for 5min and stopped transmitting for the "5min Tx timer" setting. Release the PTT momentarily and repress it to continue to transmit again.
Suggested invalid CH. (CHxxxx) from: xxxxxxxxx	OK	Detected the invalid work channel (CHxxxx) in the received call from a station (MMSI: xxxxxxxxx).
The MMSI has been registered.	----	The caller's MMSI has been registered on the station list.
The TEL number has been registered.	----	The caller's telephone number has been registered on the PSTN number list.
This address means a coast station call. Change menu or retry?	Change/ Retry	The input address is for a coast station. Change the menu for a coast station call or retry to input the address? Change: Changes the menu. Retry: Returns to the current menu.
This address means a group call. Change menu or retry?	Change/ Retry	The input address is for a group ships. Change the menu for a group call or retry to input the address? Change: Changes the menu. Retry: Returns to the current menu.
TIME OUT The DSC channel 70 has been occupied continuously!	OK	Broke the DSC call process because the CH70 has been occupied continuously.
Time out... Returning to editing screen.	----	There is no acknowledgement within 5min, and returns to the editing screen.
Transceiver busy	OK	There is no reply from the transceiver.
Transmission was slightly interrupted by 5 minutes timer automatically.	OK	The transmission has continued for 5min and stopped transmitting slightly for the "5min Tx timer" setting.
Unable to comply from: xxxxxxxxx Reason: Queue Wait for ring-back?	Wait/ Cancel	After a PSTN call (MMSI: xxxxxxxxx), received the unable to comply (queue) acknowledgement. Wait: Sets to wait for a ring back. Cancel: Ceases the PSTN call.
Up to 2 printers are connectable.	OK	The printer setting is not valid. Up to 2 printers are connectable for the VHF system.
VESSEL CALL PROCESS Select call type.	Urgency/ Safety/ Routine/ Cancel	Call a station using AIS information. Urgency: Individual urgency call Safety: Individual safety call Routine: Individual routine call Cancel: Ceases the call operation.
View alarm history?	OK/ Cancel	View the alarm history? OK: Views the alarm history. Cancel: Cancels this operation.
Wait a moment, please.	----	Shifting the condition now, and wait a moment.
Waiting for Acknowledgement.	Cancel	After sending the DSC call, waiting for the acknowledgement.
Waiting for the ring back now. Is it OK to break this condition?	OK/ Cancel	The PSTN call menu is waiting for the ring back call now. Is it ok to break? OK: Breaks the condition to send a new call now. Cancel: Continues to wait the call.

5. SETTINGS & REGISTRATIONS

This chapter describes the procedure for settings and registrations for the date and time manually, the contact lists for DSC calls, advanced DSC settings, and other settings for the equipment.

5.1 Date and time setting

Normally, the date and time will be updated automatically if importing GPS information. But if necessary, input these parameters manually as follows.

CAUTION



The time described below means the present time, and is different from the time in the menu 9.2 POS/TIME that means the time when the position information is valid.

■ Procedure ■

1. Press the **MENU** key, and through hierarchical menus, select the 9.1 Date & time.

```
9.1)Date & time
1. Date      : '06-12-31
2. Present time : 23:59
3. Display form
  - Type      : Time, pos
  - UTC/LT    : UTC
  - LT diff   :      :
  - Date format : 'YY-MM-DD
0. Back
```

2. To input the date, press ENT.

Input the year, month, and date with the numeric keypad or jog dial. (When using the jog dial, select the value and press ENT for each digit.)

```
9.1)Date & time
1. Date      : '06-12-31
2. Present time : 23:59
3. Display form
  - Type      : Time, pos
  - UTC/LT    : UTC
  - LT diff   :      :
  - Date format : 'YY-MM-DD
0. Back
```

3. After completed the above steps, the cursor will move to 2. Present time.

```
9.1)Date & time
1. Date      : '06-12-31
2. Present time : 23:59
3. Display form
  - Type      : Time, pos
  - UTC/LT    : UTC
  - LT diff   :      :
  - Date format : 'YY-MM-DD
0. Back
```

Settings & Registrations

4. To input the present time (UTC), press ENT.

- Input the hours and minutes with the numeric keypad or jog dial. (When using the jog dial, select the value and press ENT for each digit.)
- To finish this menu, place the cursor on the any one of the selective items and press the **CANCEL** key.

```
9.1)Date & time
1.Date      : '06-12-31
2.Present time : 23:59
3.Display form
  - Type      : Time, pos
  - UTC/LT    : UTC
  - LT diff   :
  - Date format : 'YY-MM-DD
0.Back
```

Note

In addition to the above, the following items can be set in this menu.

- Type: Select a type shown on the status display from below.
 - "Time,pos" : Displays both of the present time and position.
 - "Time" : Displays only the present time.
 - "Pos" : Displays only the present position.
- UTC/LT: Select a type of time shown on the screen.
- LT diff: Set the local time difference to display the local time.
- Date format: Select a type of date shown on the DSC message lists or the alarm history from below.
 - "YY-MM-DD" : Displays December 31, 2006 as '06-12-31.
 - "MMM DD,'YY" : Displays December 31, 2006 as Dec 31,'06.
 - "DD MMM,'YY" : Displays December 31, 2006 as 31 Dec,'06.

5.2 Own ship position and time setting

Normally, the ship's position and the time will be updated automatically if importing GPS information. But if necessary, input these parameters manually as follows.



CAUTION



The time described below means the time when the position information is valid, and is different from the present time mentioned above.

■ Procedure ■

1. Press the **MENU** key, and through hierarchical menus, select the 9.2 POS/TIME.

```
9. 2) POS/TIME
1. Own position: NE
                89° 59' N
                179° 59' E
2. UTC of position:
                23:59
```

2. To input own ship's position, press ENT.

Select the position quadrant with the jog dial, and press ENT. Then input the latitude and longitude, and press ENT with the numeric keypad or jog dial.

```
9. 2) POS/TIME
1. Own position: NE
                89° 59' N
                179° 59' E
2. UTC of position:
                23:59
```

3. After completed the above steps, the cursor will move to the 2. UTC of position.

```
9. 2) POS/TIME
1. Own position: NE
                89° 59' N
                179° 59' E
2. UTC of position:
                23:59
```

4. To input the UTC of position, press ENT.
 - Input the hours and minutes, and press ENT.
 - To finish this menu, place the cursor on the any one of the selective items and press the **CANCEL** key.

```
9. 2) POS/TIME
1. Own position: NE
                89° 59' N
                179° 59' E
2. UTC of position:
                23:59
```

Note

- If received the position and the time information from the external device, such as a GPS, the manually entered data will be overwritten automatically.
- If not received the position and the time information within 5 minutes after powering on, or after 5 minutes elapsed since interrupted, this menu will appear with the alarm automatically. Further, regardless of either manually or automatically if not updated the position and the time within 4 hours after the last entry, this menu will appear repeatedly.

5.3 Settings for each Controller

The following describes the procedure regarding individual settings for controller such as LCD adjustment.

5.3.1 LCD adjustment

The LCD conditions for viewability are adjustable as follows.

■ Procedure ■

1. Press the **MENU** key, and through hierarchical menus, select the 9.3.1 LCD adjustment.

The screen as shown at right will be displayed.

```

9.3.1) LCD adjustment
1. Contrast : 06
2. Dimmer
   Maximum : 10
   Typical  : 08
   Minimum  : 06
3. Screen saver : OFF
   Timer(sec) : 060
0. Back
    
```

2. Move the cursor to the desired item and press ENT. Then alter the settings as appropriate with the numeric keypad or jog dial and press ENT again.

- Set each item within the ranges given below.
 - Contrast: 1 - 13
 - Dimmer: 1 - 10
 - Screen saver: ON/OFF
 - Timer: 1 - 999 seconds
- To finish this menu, place the cursor on any one of the selective items and press the **CANCEL** key.

```

9.3.1) LCD adjustment
1. Contrast : 06
2. Dimmer
   Maximum : 10
   Typical  : 08
   Minimum  : 06
3. Screen saver : OFF
   Timer(sec) : 060
0. Back
    
```

5.3.2 Sound settings

The sound settings such as the click beep are adjustable as follows.

■ Procedure ■

1. Press the **MENU** key, and through hierarchical menus, select the 9.3.2 Sound.

The screen as shown at right will be displayed.

```

9.3.2) Sound
1. Operation
   - Internal speaker : ON
   - Click            : ON
2. Phone level adj. : 7
3. Notification level : 7
0. Back
    
```

2. Move the cursor to the desired item and press ENT. Then set the conditions as appropriate with the numeric keypad or jog dial and press ENT again.

- The phone level can be set within 1 - 8.
- The notification level for such as a tone of the popup screen can be set within 1 - 7.
- To finish this menu, place the cursor on any one of the selective items and press the **CANCEL** key.

```

9.3.2) Sound
1. Operation
   - Internal speaker : ON
   - Click            : ON
2. Phone level adj. : 7
3. Notification level : 7
0. Back
    
```

5.3.3 User key assignment

User key assignment enables the desired menu to be displayed immediately without moving through the hierarchy menus, and is assignable as follows.

■ Procedure ■

1. Press the **MENU** key, and through hierarchical menus, select the 9.3.3 User key assign.

The screen at right will be displayed. If already been registered, the cursor will be placed on that menu.

```

9.3.3)User key assign
1.DSC coast station call
2.DSC ship station call
3.DSC PSTN call
4.DSC group call
5.DSC emergency call
6.DSC test call
▼ 7.DSC logs
  
```

2. Move the cursor to the desired menu to be registered with the jog dial.

The assignable menus are as follows.

1. DSC coast station call	(Menu1.1)	19. CH SQL setting	(Menu7.7)
2. DSC ship station call	(Menu1.2)	20. Self diagnosis	(Menu8.1)
3. DSC PSTN call	(Menu1.3)	21. DSC loop	(Menu8.1.5)
4. DSC group call	(Menu1.4)	22. Alarm information	(Menu8.2)
5. DSC emergency call	(Menu2)	23. System information	(Menu8.3)
6. DSC test call	(Menu3)	24. DSC AF inspection	(Menu8.5)
7. DSC logs	(Menu4)	25. Date & time	(Menu9.1)
8. AIS other ships list	(Menu5.1)	26. POS/TIME	(Menu9.2)
9. AIS proximity range	(Menu5.3)	27. My controller	(Menu9.3)
10. Playback	(Menu6.1)	28. Contact list	(Menu9.4)
11. Public address	(Menu6.2)	29. DSC operation	(Menu9.5)
12. Intercom	(Menu6.3)	30. Printer property	(Menu9.7)
13. Scan	(Menu7.1)	31. Dedicated ENT key	---
14. Dual watch	(Menu7.2)	32. CH dial lock ON/OFF	---
15. Memory channel list	(Menu7.3.1)		
16. Private channel	(Menu7.4)		
17. Weather channel	(Menu7.5)		
18. Region	(Menu7.6)		

```

9.3.3)User key assign
1.DSC coast station call
2.DSC ship station call
3.DSC PSTN call
4.DSC group call
5.DSC emergency call
6.DSC test call
▼ 7.DSC logs
  
```

3. Press ENT to complete registration.

- After registration, the screen will return to the previous hierarchical menu as shown at right.
- To finish this menu, place the cursor on the any one of the selective items and press the **CANCEL** key.

```

9.3)My controller
1.LCD adjustment
2.Sound
3.User key assign
4.Name :[Station ]
5.Hook switch: Valid
6.Off-hook notice: OFF
0.Back
  
```

Note

When the **USER** key is pressed in the factory default setting, this menu is immediately displayed.

5.3.4 Name a controller

When connecting multiple controllers, each controller can be named respectively to make identification easier. The name of each controller is always displayed on the top left of the screen.

■ Procedure ■

1. Press the **MENU** key and through hierarchical menus, select the 9.3 My controller.

The screen as shown at right will be displayed.

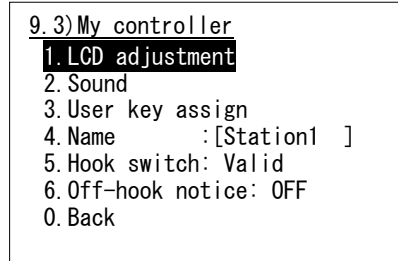

2. Move the cursor to the 4. Name with the numeric keypad or jog dial.

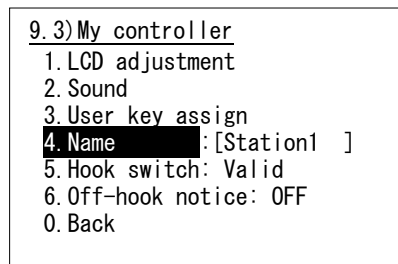

3. Press ENT to name the controller.

- Up to 10 alphanumeric characters available.
 - Assigned "StationX (X: address No.)" by default.
 - The following characters are available.
 - Alphabet (capital and small letters)
 - Numbers 0 - 9
 - The following signs, space and determination(◀).
- [] _ " # % & ' () ? @ + - / = : ; < >

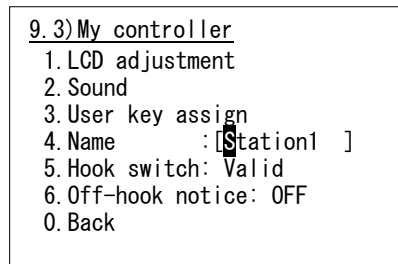

4. Select a character and press ENT one by one.

- To change the character at the cursor position, rotate the jog dial to select the character, and press ENT to move the cursor to the right. Further, when using the numeric keypad to input numbers, pressing ENT is not needed.
- Only to move the cursor to the right, press ENT.
- To return to the previous letter, press the **CANCEL** key.
- To complete the name entry of 10 characters long, press ENT after selecting the last character by the jog dial. Or if less than 10 characters long, following the name, select the determination as shown at right, and press ENT.

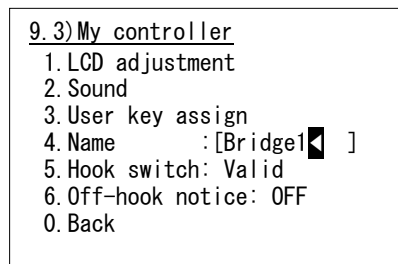

Note

The characters sequence shown by turning the jog dial is as follows.

◀ A B C D E F G H I J K L M N O P Q R S T U V W X Y Z a b c d e f g h i j k l m n o p q r s t
 u v w x y z [] _ " # % & ' () ? @ + - / = : ; < > 0 1 2 3 4 5 6 7 8 9 [](space)

5.3.5 Disabling the hook switch

The hook switch for the handset can be disabled not to set to CH16 by returning the handset to the cradle. (As a factory default setting, the hook switch has been set to "Valid".)

■ Procedure ■

1. Press the **MENU** key, and through hierarchical menus, select the 9.3 My controller.

```
9.3)My controller
1. LCD adjustment
2. Sound
3. User key assign
4. Name      : [Bridge1  ]
5. Hook switch: Valid
6. Off-hook notice: OFF
0. Back
```

2. Move the cursor to the 5. Hook switch with the numeric keypad or jog dial.

```
9.3)My controller
1. LCD adjustment
2. Sound
3. User key assign
4. Name      : [Bridge1  ]
5. Hook switch: Valid
6. Off-hook notice: OFF
0. Back
```

3. Press ENT.

The cursor will move to the right.

```
9.3)My controller
1. LCD adjustment
2. Sound
3. User key assign
4. Name      : [Bridge1  ]
5. Hook switch: Valid
6. Off-hook notice: OFF
0. Back
```

4. Select the condition and press ENT with the jog dial.

- When selecting "Invalid", deletes the line of "6. Off-hook notice" and the cursor will move to 0. Back.
- To finish this menu, place the cursor on the 0.Back and press ENT, or on any one of the selective items and press the **CANCEL** key.

```
9.3)My controller
1. LCD adjustment
2. Sound
3. User key assign
4. Name      : [Bridge1  ]
5. Hook switch: Invalid
0. Back
```

Note

When selecting "Valid" and then set the condition of the "6. Off-hook notice" to ON, the popup screen as shown at right will be displayed if left the handset without returning to the cradle.

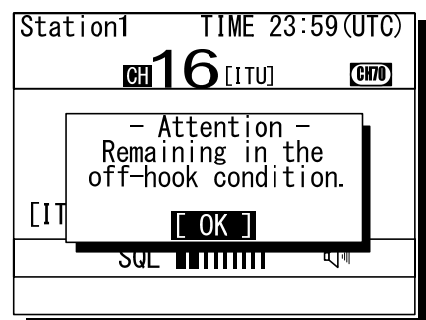

5.4 Creating contact lists

The following describes the procedure to create the contact lists for a coast station or ship station call, or for a group call via DSC. Additionally, the PSTN number list can be created using the similar procedure.

(1) Making a new list

■ Procedure ■

1. Press the **MENU** key, and through hierarchical menus, select the 9.4 Contact list.

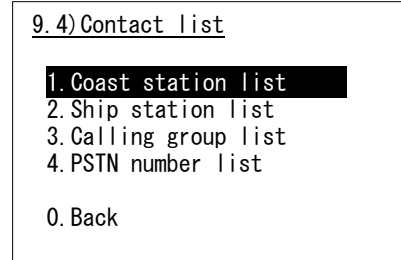

2. Select the desired list to be created with the numeric keypad or jog dial.

The example at right shows the coast station list. The following is the procedure in the case of the coast station list, but is essentially the same with the case of the ship station list, the group list, or the PSTN number list.

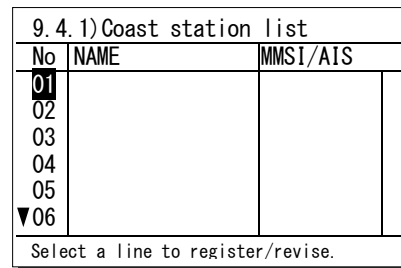

3. Select a line number and press ENT.

The screen becomes the name entry mode. If the name is left blank and "◀" is pressed, "Unknown" is displayed and the cursor is moved to MMSI column.

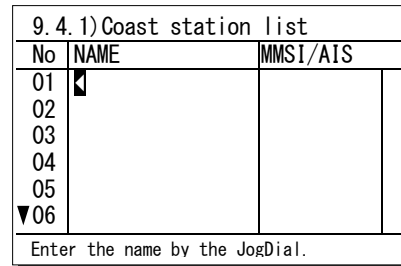

4. Input characters of a name by selecting a character with the jog dial and ENT one by one.

- Up to 14 alphanumeric characters available.
- Other procedure are essentially the same with the name entry procedure in the 9.3 My controller.

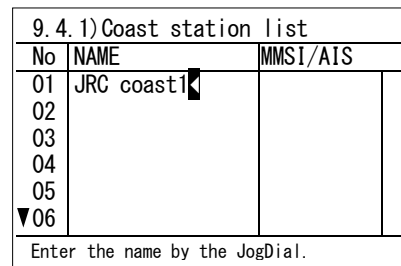

5. After completed the name entry, the cursor will move to the MMSI column.
 - Input the MMSI with the numeric keypad or jog dial.
 - For coast stations, "00" will be inserted automatically at the start of the line, and then the line will be ready for entering numbers. (In the case of the group list, "0" will be added as well.)
 - When using the numeric keypad, input all digits consecutively.
 - When using the jog dial, select a number and press ENT for each digit repeatedly.

9. 4. 1)Coast station list		
No	NAME	MMSI/AIS
01	JRC coast1	00
02		
03		
04		
05		
▼06		

Enter the 9-digit MMSI.

6. After completed the MMSI entry, the cursor will move to the AIS column.

To activate the AIS proximity check function for the station, check "v" sign with the jog dial.

9. 4. 1)Coast station list		
No	NAME	MMSI/AIS
01	JRC coast1	001234567
02		
03		
04		
05		
▼06		

Select v for AIS proximity check.

7. After completed the entry of the station, press ENT to move the cursor to the next line number.
 - Follow the same procedure above to create the radio station list.
 - To finish this menu, place the cursor on any one of the registration numbers and press the **CANCEL** key.

9. 4. 1)Coast station list		
No	NAME	MMSI/AIS
01	JRC coast1	001234567 v
02		
03		
04		
05		
▼06		

Select a line to register/revise.

- Note**
- The maximum registerable number is 80 for each of the coast station list, the ship station list, and the PSTN number list, and is 20 for the calling group list.
 - The registerable telephone number digits are 1 to 16 and the registration screen will be as shown below.

9. 4. 4)PSTN number list		
No	NAME	TEL number
01	JRC office1 <	>1234567890123456
02	JRC office2 <	>0018143215678
03	<	>
▼	>	

Select a line to register/revise.

(2) Revising a list

■ Procedure ■

1. Select the registration number to be revised at step3 above, and press ENT.

The example at right shows the case of the No.1 selected to revise the content.

9. 4. 1)Coast station list			
No	NAME	MMSI/AIS	
01	JRC coast1	001234567	v
02	JRC coast2	002345678	
03	JRC coast3	003456789	
04	JRC coast4	004567890	
05	JRC coast5	005678901	
▼06	JRC coast6	006789012	

Enter the name by the JogDial.

2. To change the name, change the characters with the jog dial and ENT one by one.

- The procedure is basically similar with the step4 mentioned above.
- Only to move the cursor to the right, press ENT. Additionally, when moving the cursor without changing the name, enter the determination character at the end of the name.

9. 4. 1)Coast station list			
No	NAME	MMSI/AIS	
01	ABC coast	001234567	v
02	JRC coast2	002345678	
03	JRC coast3	003456789	
04	JRC coast4	004567890	
05	JRC coast5	005678901	
▼06	JRC coast6	006789012	

Enter the name by the JogDial.

3. After completed the name revising, the cursor will move to the MMSI column.

- Change the digits of the MMSI with the numeric keypad or jog dial.
- Only to move the cursor to the right, press ENT.

9. 4. 1)Coast station list			
No	NAME	MMSI/AIS	
01	ABC coast	001234567	v
02	JRC coast2	002345678	
03	JRC coast3	003456789	
04	JRC coast4	004567890	
05	JRC coast5	005678901	
▼06	JRC coast6	006789012	

Enter the 9-digit MMSI.

4. After completed the MMSI revising, the cursor will move to the AIS column.

- If required, change the status with the jog dial and press ENT.
- If not required to change the status, press ENT.

9. 4. 1)Coast station list			
No	NAME	MMSI/AIS	
01	ABC coast	001111111	v
02	JRC coast2	002345678	
03	JRC coast3	003456789	
04	JRC coast4	004567890	
05	JRC coast5	005678901	
▼06	JRC coast6	006789012	

Select v for AIS proximity check.

5. After completed, the cursor will move to the next line number.

To finish this menu, press the **CANCEL** key.

9. 4. 1)Coast station list			
No	NAME	MMSI/AIS	
01	ABC coast	001111111	
02	JRC coast2	002345678	
03	JRC coast3	003456789	
04	JRC coast4	004567890	
05	JRC coast5	005678901	
▼06	JRC coast6	006789012	

Select a line to register/revise.

Note

- When the cursor is placed on the line number, pressing two digits of the number enables to move the cursor to the specified number.
- To erase a registered line, select a space at the beginning of the name and press ENT.
- To erase all data of the currently displaying list, select "00. ALL CLEAR function" button and press ENT.

5.5 Advanced settings for DSC

The following describes the procedure for the advanced DSC settings such as automatic acknowledgement, as well as creating a PSTN number list.

■ Menu screen ■

Press the **MENU** key, and through hierarchical menus, select the 9.5 DSC operation.

The following describes the procedures from this screen.
Note that the screen at right shows factory default settings.

9.5) DSC operation	
1. Automatic ACK	: ON
2. Automatic CH shift	: ON
3. Safety/Routine ALM	: ON
4. Medical/Neutral use	: OFF
5. Expanded MMSI	: 0
0. Back	

5.5.1 Automatic acknowledgement

If the automatic acknowledgement is set to ON, and when received any one of the individual calls below, the acknowledgement will be sent automatically without notice.

- Routine - a polling call
- Safety - a position request call
- Safety - a test call

This function will be disabled in distress mode or PSTN communication mode, or while the PTT is ON. Furthermore, if performed this function during dual watch or scanning, the channel dwell time might be longer than usual.

■ Procedure ■

To activate the automatic acknowledgement function, set the 1. Automatic ACK condition to ON with the jog dial.

5.5.2 Disabling the automatic channel shift

When receiving any one of the following DSC calls having a valid working channel, the radiotelephone channel can be shifted automatically to the specified channel. (Note : For the other DSC calls, the channel shift can be performed manually.)

- Routine - a group call
- Safety - an All ship call
- Routine/ Safety/ Urgency - an acknowledgement to the individual call own ship has transmitted before.

However, to avoid disruption of the important ongoing communication, this function must be disabled according to the menu operation. The following describes the procedure to disable this function.

■ Procedure ■

To disable the automatic channel shift function, set the 2. Automatic CH shift condition to OFF with the jog dial.

5.5.3 Disabling receiving alarms for routine and safety calls

The aural alarm for routine and safety calls can be disabled as follows.

■ Procedure ■

To disable the receiving alarms for routine and safety calls, set the 3. Safety/Routine ALM condition to OFF with the jog dial.

5.5.4 Medical/Neutral use setting for urgency calls

The following describes the procedure to set the condition so that an urgency all ships call containing the additional subject of either "Medical transportation" or "Neutral nationality" can be sent. Additionally, note that this setting will return to the default setting (OFF) if the power is turned off.

■ Procedure ■

To use these kinds of calls, set the 4. Medical/Neutral use condition to ON with the jog dial.

5.5.5 Expanded MMSI registration

If existing multiple DSC devices having the same 9-digit MMSI on board a ship, setting the 10th digit of the MMSI number to a non-zero value is available to distinguish them in the case of routine individual calls. The handling of 10-digit MMSI is as follows.

- When sending a routine individual call, the caller ID (own ship station's MMSI) will be 10-digit MMSI.
- When receiving a routine individual call, the DSC having the identical address only will treat the message, i.e. mainly the DSC having "0" as the 10th digit of MMSI will receive an individual call addressed to the own station.
- When sending an acknowledgement to a received individual call, the address of the call will be entered the caller's ID of the individual call as it is, i.e. if the 10th digit of the caller's ID is not "0", the address will be 10-digit MMSI automatically.

■ Procedure ■

To register the 10th digit of own MMSI, set the number to the 5. Expanded MMSI condition with the numeric keypad or the jog dial.



CAUTION



Usually, it is not necessary to set it as any values other than zero."0".
Please be sure to set the VHF transceiver installed in a bridge as "0"
When values other than "0" are set up, DSC may be unable to receive.

5.6 Other settings

The following describes the procedure to set the conditions regarding the AIS information import, the printer property, and preset squelch with respect to each channel.

5.6.1 Enabling the AIS function

When connecting the AIS to use the information for such as a DSC call, set the import condition to ON as follows.

■ Procedure ■

1. Press the **MENU** key, and through hierarchical menus, select the 9.6 AIS function.

Note The factory setting is default "ON".

9.6) AIS function

1. Import : OFF

0. Back

2. Press ENT. Then set the import condition to ON with the jog dial.

9.6) AIS function

1. Import : **ON**

0. Back

3. Press ENT to complete the setting.

The cursor will move to the 0. Back.

9.6) AIS function

1. Import : ON

0. Back

5.6.2 Printer property

When connecting the printers, configure the conditions as appropriate according to the printer type, as follows.

■ Procedure ■

1. Press the **MENU** key, and through hierarchical menus, select the 9.7 Printer property.

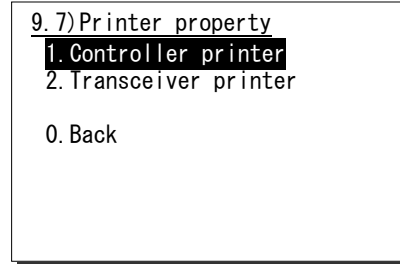

2. Select the intended printer and press ENT.

When selected the 1. Controller printer, the screen at right will be displayed.

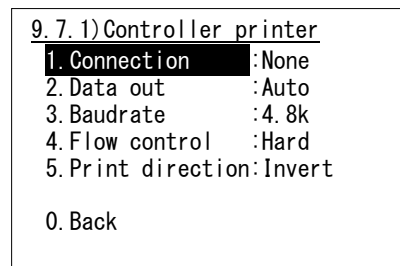

3. Move the cursor to the desired item and press ENT.

The cursor will move to the right. After that, select the condition as appropriate and press ENT.

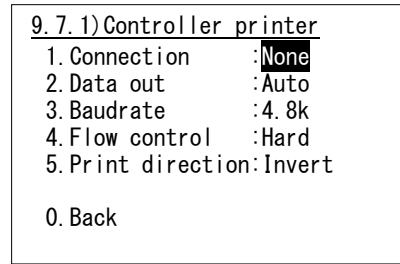

Note - The content and the selective conditions of each item are as follows.

Printer type	Selective item	Content	Selective conditions (█ : Factory default)
Controller printer	Connection	Connection status and the printer type	None / Serial
	Data out	Printing method for the DSC message	Auto / Manual
	Baudrate	Transmission speed to the printer	4.8k / 9.6k/ 38.4kbps
	Flow control	Handshake setting with the printer	Hard / None
	Print direction	Printing sequence of the lines	Invert / Upright
Transceiver printer	Connection	Connection status and the printer type	None /NKG-52/Centronics
	Data out	Printing method for the DSC message	Auto/ Manual
	Print direction	Printing sequence of the lines	Invert / Upright (NKG-52: "Invert" only)

- When connect NKG-91 printer, please set up as follows.
 - 1.Connection: Serial
 - 2.Data out: Auto
 - 3.Baudrate: 4.8k
 - 4.Flow control: Hard
 - 5.Print direction: Invert

- When connect DPU-414 printer, please set up as follows.
 - 1.Connection: Serial
 - 2.Data out: Auto
 - 3.Baudrate: 4.8k
 - 4.Flow control: Hard
 - 5.Print direction: Upright

- When connect NKG-52 printer, please set up as follows.
 - 1.Connection: NKG-52
 - 2.Data out: Auto
 - 3.Print direction: Invert

6. MAINTENANCE & INSPECTION

The performance and lifetime of the equipment depend on the appropriate maintenance. This chapter describes the maintenance and inspection, self diagnosis, and outline of adjustment.

6.1 General maintenance & inspection

In order to operate the equipment under optimum conditions, it is vital to perform regular inspections and also, to keep accurate records. Inspections enable problems to be identified before they become major malfunctions. The following inspections should be made regularly.

Inspection sequence	Inspection items	Procedure
1	Antenna system	Check that antennas and the connectors are secure.
2	Squelch operation	Lift the handset of the controller with the access rights, and turn the SQL control fully counterclockwise. Check for noise from the speaker. Check noise to be suppressed by turning the SQL control clockwise.
3	Receiver condition checked by speaker output.	Check that the voice level and noise level are not abnormally loud or soft.
4	Handset PTT switch	Press PTT and check that the unit transmits immediately and that TX is displayed on the screen.
5	Transmission and reception checked by performing radio communication.	Check that normal conversation is possible.

6.2 Self diagnosis inspection

The following describes the procedure to perform the self diagnosis with the menu 8.1 Self diagnosis.

■ Procedure ■

1. Press **FUNC** → **8TEST** .

The menu shown at right will be displayed.

8.1) Self diagnosis

```

1. Transceiver
2. Controller
3. Transceiver log
4. Controller log
5. DSC loop
0. Back
    
```

2. Select 1. Transceiver or 2. Controller with the numeric keypad or the jog dial.

If selected "1. Transceiver", the screen at right will be displayed.

8.1.1) Transceiver

```

Start checking of ALL
- ROM      : --
- RAM      : --
- SIO      : --
- MODEM    : --
- Loop     : --
- PS (DC/DC) : --
- Printer  : --
    
```

3. Select a test type with the jog dial and press ENT.

- The self diagnosis will be performed.
- The following test modes are available.

8.1.1) Transceiver ALL (All modes)
 DGT CKT (ROM/RAM/SIO)
 MODEM (MODEM only)
 Loop (Loop only)
 PS (PS(DC/DC) only)
 Printer (Printer only)

8.1.2) Controller ALL (All modes)
 DGT CKT (ROM/RAM/SIO)
 LCD&LED (LCD&LED only)
 Printer (Printer only)
 Speaker (Speaker only)

8.1.1) Transceiver

```

Start checking of ALL
- ROM      : OK
- RAM      : OK
- SIO      : OK
- MODEM    : OK
- Loop     : OK
- PS (DC/DC) : OK
- Printer  : DONE
    
```

Note

- Only the case where printer setup is ON can choose Printer in test mode.
- To break off the self diagnosis, press the **CANCEL** key.
- The results of the self diagnosis are stored and the latest up to 10 logs can be confirmed from the menu 8.1.3 Transceiver log or 8.1.4 Controller log.
- The self-diagnosis test contents and results are as shown below.

Unit Name	Test Item	Contents	Results
Transceiver	ROM	<ul style="list-style-type: none"> ROM1 (Flash) read/write ROM2 (EEP) read/write 	OK :Normal ROM1 NG :ROM1 error ROM2 NG :ROM2 error ROM12 NG :ROM1 & 2 error
	RAM	<ul style="list-style-type: none"> RAM (SDRAM) read/write 	OK :Normal NG :Error
	SIO	<ul style="list-style-type: none"> RS-485 line loop-back test 	OK :Normal NG :Error
	MODEM	<ul style="list-style-type: none"> MODEM1 (M0-M1) loop-back test MODEM2 (M1-M0) loop-back test 	OK :Normal MODEM1 NG :MODEM1 error MODEM2 NG :MODEM2 error MODEM12 NG :MODEM1 & 2 error
	Loop	<ul style="list-style-type: none"> Loop1 (TX-RX) loop-back test Loop2 (TX-WKR) loop-back test 	OK :Normal Loop1 NG :Loop1 error Loop2 NG :Loop2 error Loop12 NG :Loop1 & 2 error
	PS(DC/DC)	<ul style="list-style-type: none"> DC/DC PWR output voltage check 	OK :Normal NG :Error
	Printer	<ul style="list-style-type: none"> Print out test 	<ul style="list-style-type: none"> Check visually if printed out correctly. After performed, this line on the screen shows "DONE".
Controller	ROM	<ul style="list-style-type: none"> ROM1(Flash) read/write ROM2(EEP) read/write 	OK :Normal ROM1 NG :ROM1 Error ROM2 NG :ROM2 Error ROM12 NG :Error in both
	RAM	<ul style="list-style-type: none"> RAM(SDRAM) read/write 	OK :Normal NG :Error
	SIO	<ul style="list-style-type: none"> RS-485 line loop-back test 	OK :Normal NG :Error
	LCD&LED	<ul style="list-style-type: none"> Every pixel (dot) of the LCD and ALM lamp display test 	<ul style="list-style-type: none"> Check visually if every dot and the red and green ALM lamp alternately work normally for 3 seconds. After performed, this line on the screen shows "DONE".
	Printer	<ul style="list-style-type: none"> Print out test 	<ul style="list-style-type: none"> Check visually if printed out correctly. After performed, this line on the screen shows "DONE".
	Speaker	<ul style="list-style-type: none"> Sound test 	<ul style="list-style-type: none"> Check aurally if the 1500Hz tone sounds correctly. After that, press ENT on the popup screen to finish this process. After performed, this line on the screen shows "DONE".

6.3 System alarm indication

If detected errors regarding the equipment, the screen shows the alarm information as follows.

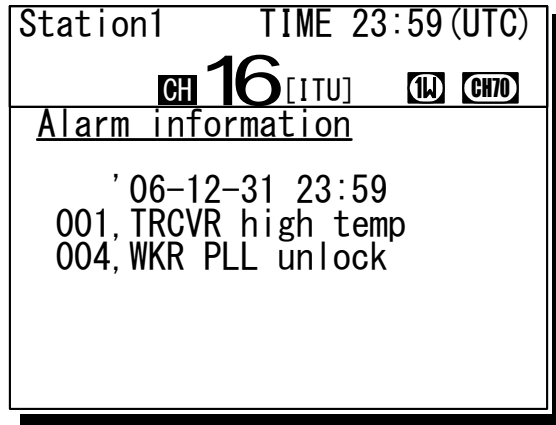

Note

- According to the alarm type, some features and functions may be automatically restricted. The alarm information is formatted as follows.

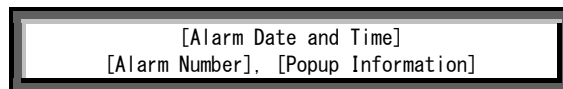

- To return to the previous screen, press the **CANCEL** key.
- When occurring 002.TX PLL unlock alarm or 003.RX PLL unlock alarm, a blinking **UNLOCK** mark will be additionally indicated. In this case, that mark will be remained as shown below until restored to the normal condition.

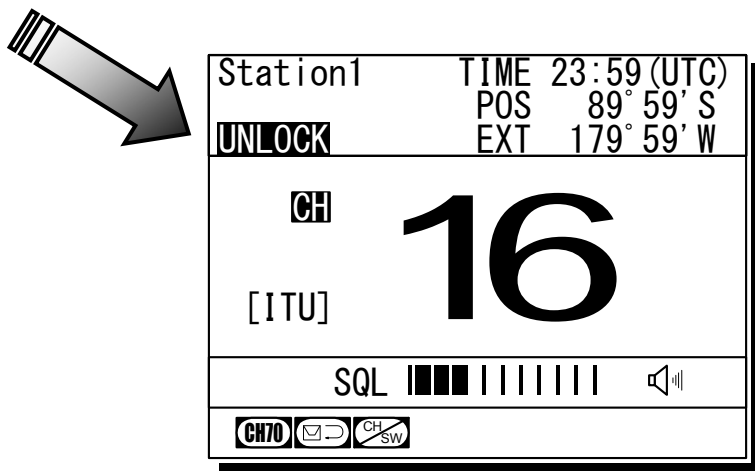

6.3.1 Alarm list

The following list shows the types of system alarm and contents.

Alarm Number	Display	Contents	Troubleshooting Procedure
001	TRCVR high temp	Detected the abnormally high temperature in the transceiver.	Stop transmission, or reduce the power to 1W
002	TX PLL unlock	Detected PLL Unlock in the transmitter.	<i>Please contact JRC or our agency.</i>
003	RX PLL unlock	Detected PLL Unlock in the receiver.	<i>Please contact JRC or our agency.</i>
004	WKR PLL unlock	Detected PLL Unlock in the watch-keeping receiver.	<i>Please contact JRC or our agency.</i>
005	TRCVR memory	Detected the transceiver memory error.	<i>Please contact JRC or our agency.</i>
006	CTLR1 memory	Detected the memory error in controller 1.	<i>Please contact JRC or our agency.</i>
007	CTLR2 memory	Detected the memory error in controller 2 or channel selector 2.	<i>Please contact JRC or our agency.</i>
008	CTLR3 memory	Detected the memory error in controller 3 or channel selector 3.	<i>Please contact JRC or our agency.</i>
009	CTLR4 memory	Detected the memory error in controller 4 or channel selector 4.	<i>Please contact JRC or our agency.</i>
010	CTLR5 memory	Detected the memory error in controller 5 or channel selector 5.	<i>Please contact JRC or our agency.</i>
011	CTLR1 SIO	Detected the serial communication error in controller 1.	<i>Please contact JRC or our agency.</i>
012	CTLR2 SIO	Detected the serial communication error in controller 2 or channel selector 2.	<i>Please contact JRC or our agency.</i>
013	CTLR3 SIO	Detected the serial communication error in controller 3 or channel selector 3.	<i>Please contact JRC or our agency.</i>
014	CTLR4 SIO	Detected the serial communication error in controller 4 or channel selector 4.	<i>Please contact JRC or our agency.</i>
015	CTLR5 SIO	Detected the serial communication error in controller 5 or channel selector 5.	<i>Please contact JRC or our agency.</i>
016	GPS SIO	Detected the GPS communication error	<i>Please contact JRC or our agency.</i>
017	Serial printer1	Detected an alarm of the printer 1.	Check the printer power or the paper empty.
018	Serial printer2	Detected an alarm of the printer 2.	Check the printer power or the paper empty.
019	Parallel printer	Detected an alarm of the Centronics type printer connected to the transceiver.	Check the printer power or the paper empty.
020	MMSI lost	The MMSI has not been registered yet, or has been lost.	<i>Please contact JRC or our agency.</i>
021	Own CTLR ID	Detected the ID error in the controller displaying this message. It is recorded on the alarm history as alarm of No. 011-015.	<i>Please contact JRC or our agency.</i>
022	Own CTLR SIO	Detected the loss of communication with the transceiver via RS-485 lines. It is recorded on the alarm history as alarm of No. 011-015. However, it may not be recorded on the alarm history.	<i>Please contact JRC or our agency.</i>
023	PTT line	Detected malfunction regarding PTT line.	<i>Please contact JRC or our agency.</i>
024	TRCVR PS (DC/DC)	Detected DC/DC power supply error.	<i>Please contact JRC or our agency.</i>
025	TRCVR PS (FUSE)	Detected PS error at the RF circuit, e.g. the fuse blown.	Check or replace the fuse (F3) on the CBD-7701 T/B.
026	Abnormal RF power	Detected malfunction in the transmission circuit or the duplexer connection.	<i>Please contact JRC or our agency.</i>
027	POWER-OFF failure	Detected malfunction regarding power supply control circuit.	<i>Turn OFF the power switch in the transceiver or of the external power source, and then please contact JRC or our agency.</i>

6.3.2 Viewing the alarm history

The following describes the procedure to confirm the current alarm condition or the alarms occurred in past time.

■ Procedure ■

1. Press the **MENU** key, and through hierarchical menus, select the 8.2 Alarm information.

According to the alarm occurring condition, the screen will be displayed as shown at right.

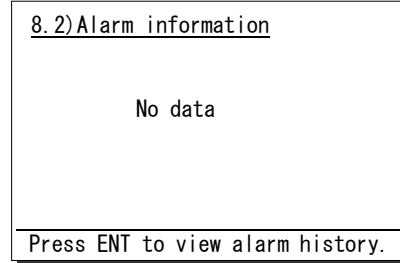

(In the case of no current alarm)

Note The displayed alarm information is formatted as follows.

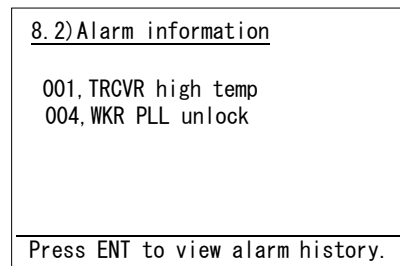
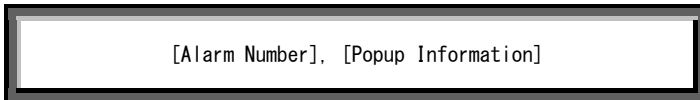

(In the case of alarms occurring)

2. To check the alarm history, press ENT.
After the popup screen at right will be displayed, select OK.

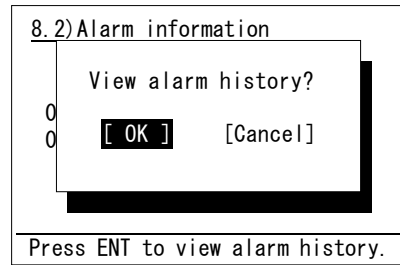

3. The alarm history will be displayed.
The latest up to 10 histories are stored.
If necessary, scroll with the jog dial.

Note The displayed alarm history is formatted as follows.

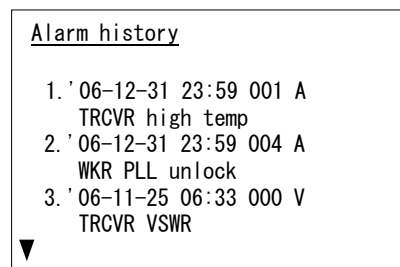
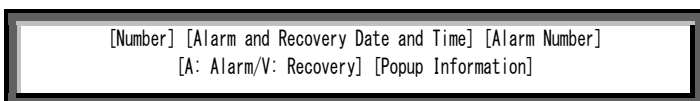

6.4 Checking the setup condition

The system information can be confirmed for use in maintenance and inspection.

6.4.1 System information

The following describes the procedure to display such as the ID numbers or peripheral connection conditions.

■ Procedure ■

1. Press the **MENU** key, and through hierarchical menus, select the 8.3 System information.

The screen as shown at right will be displayed.
If necessary, scroll with the jog dial.

```

8.3)System information
Self-ID       :123456789
Group-ID      :012345678
ATIS-ID       :9431011234
Num of CTLRs  :4
Own CTLR ID   :2
WKR           :Valid
User key asgn :AIS screen
  
```

Note The confirmable information is described below.

Item Name	Contents	Notes
Self-ID	Own ship's identification number (MMSI)	
Group-ID	The identification number of the group own ship belongs to	
ATIS-ID	The ATIS number for European inland waterways	
Num of CTLRs	The number of connected controllers	
Own CTLR ID	The address number of this controller	
WKR	The setting status to use the watch-keeping receiver	Default setting: Valid
User key asgn	The menu assigned to the user defined key	
Priority CH	The registered priority channel number	Default setting: CH16
Hook switch	The setting status to use the handset hook detection	Default setting: Valid
TX monitor	The setting status to monitor communications of a controller at the other controllers and the external speaker	Default setting: ON
Alarm wake-up	The setting status to use the automatic startup function in sleep mode if receiving a distress signal	Default setting: ON
AIS info	The AIS connection status (Receiving/ Disrupted/ Invalid)	
AME info	The AME connection status (Normal/ CS error/ Invalid)	
Serial number	The serial product number of the JHS-770S/780D	

6.4.2 Software version

To confirm the software version, press the **MENU** key and through hierarchical menus, select the 8.4 Software version.

The software version number of the transceiver and controller will be displayed as shown at right.

```

8.4)Software version

- Transceiver : 1.00
- Controller  : 1.00

0. Back
  
```

6.5 DSC AF inspection

DSC AF modulation frequencies can be checked for periodic inspections etc.

■ Procedure ■

1. Press the **MENU** key, and through hierarchical menus, select the 8.5 DSC AF inspection.

```
8.5) DSC AF inspection
1. Output port :VDR&SP
2. DSC mod type :2100Hz
3. Execution   :Start

0. Back
```

2. Select output port of DSC AF frequencies.

➤ The following ports are available.

VDR&SP	VDR terminal and controller speaker
VDR&ExHS	VDR terminal and external handset
VDR&ExSP	VDR terminal and external speaker terminal

```
8.5) DSC AF inspection
1. Output port :VDR&SP
2. DSC mod type :2100Hz
3. Execution   :Start

0. Back
```

3. Select DSC modulation frequencies.

➤ The following frequencies are available.

2100Hz	Space frequency (B)
1300Hz	Mark frequency (Y)
Dot	Dot pattern

```
8.5) DSC AF inspection
1. Output port :VDR&SP
2. DSC mod type :2100Hz
3. Execution   :Start

0. Back
```

4. Output

DSC AF sound is outputted by 3.Execution.

Sound can be stopped by the **CANCEL** key or 3.Execution once again.

```
8.5) DSC AF inspection
1. Output port :VDR&SP
2. DSC mod type :2100Hz
3. Execution   :Start

0. Back
```

6.6 Troubleshooting



WARNING



This unit is also used for the distress communication, in addition to usual communication. Contact JRC or our agent if any problem is observed in this unit on usual operation or inspection. Do NOT ignore or leave any problems of this unit.



Always use the specified fuse when replacing a fuse. Using a different fuse may result in fire or malfunction.



Do not open the equipment to inspect or repair it. Inspection or repairs by anyone other than a specialized technician may result in fire, electrical shock, or malfunction. If internal inspection or repair is necessary, contact our service center or agents.

6.6.1 Procedures for locating malfunctions

- 1) First, check the power supply voltage, fuses, and connectors.
- 2) If there are no problems with the above, use a tester to check for errors.

The following table shows the instruments required for effect repairs and the severity of the malfunctions. If required to locate the malfunction, with the exception of qualified service personnel, perform the following No. 1 and 2 only.

No.	Type of Malfunction	Examples
1	Faults requiring no instrument to locate	<ul style="list-style-type: none"> • Blown power supply fuse • Faulty contacts • Broken antenna cables • Defective switches, volume, etc. • Other problems that can be visually detected
2	Malfunctions that can be fixed with a tester and repaired	<ul style="list-style-type: none"> • Power supply voltage confirmation • Breaks in internal wiring
3	Malfunctions requiring special instrument	<ul style="list-style-type: none"> • Crystal oscillator frequency error • Decrease in transmitting power and reception sensitivity • Decrease in transmitter modulation level • Malfunctions in semiconductors, ICs, and similar equipment

6.6.2 Guide to locating faults

Use the following table as a guide to locating the causes of malfunctions in the equipment. Additionally when contacting JRC or our agency, please provide the malfunction condition.

No.	Symptom	Typical causes
1	Displays nothing on the screen.	<ul style="list-style-type: none"> Malfunction in the controller cable Abnormal power supply voltage Power supply fuse is blown Malfunction in the power switch Malfunction in the display circuit Malfunction in the control circuit
2	TX is displayed but no voice is transmitted.	<ul style="list-style-type: none"> Malfunction in the handset Malfunction in the controller cable Malfunction in the AF signal transmission circuit
3	TX is not displayed, and transmission is not possible.	<ul style="list-style-type: none"> Malfunction in the handset PTT switch Malfunction in the hook detection circuit Malfunction in the transmission circuit
4	Reception sensitivity is poor.	<ul style="list-style-type: none"> Antenna damage Break or short circuit of antenna cable Faulty contact in antenna connectors
5	No sound from the speaker even when squelch is opened without reception.	<ul style="list-style-type: none"> Malfunction in the speaker Malfunction in the SQL control Malfunction in the receiver circuit
6	Noise is output from the speaker, but own ship cannot receive any calls.	<ul style="list-style-type: none"> Antenna damage Break or short circuit in antenna cable Faulty contact in antenna connectors Malfunction in the receiver
7	Turning SQL does not suppress noise.	<ul style="list-style-type: none"> Malfunction in the SQL control Malfunction in the receiver

Note

The following are not faults.

Symptom	Possible causes	Handling
No response from other station via radiotelephone or DSC call.	No operator in that station, or unavailable to respond due to other duties.	Wait and retry later.
Unable to control the radiotelephone or DSC, but the VOL control, the dimmer, and PWR key.	That controller is in the monitor mode.	Press ENT to obtain the access right and after that, retry the operation.
Even if pressing ENT at the monitor controller, the access right cannot be obtained.	Another controller with higher priority is in use for communicating or performing menu operations.	After finished at another controller, retry the operation.
If the system is left on a screen other than the status display for a while, returns to the status display.	After 10 minutes leaving, the inactivity timer would be activated and returned to the status display.	Regulated specification by ITU-R M.493-11. (Do not leave the equipment during menu operation.)
The received distress call log have erased without operating.	Received distress calls are automatically deleted after 48 hours.	Regulated specification by IMO A.803(19).
When a portable transceiver is brought close to a controller, noise comes out from a portable transceiver.	It is based on the influence of the radio frequency noise slightly generated from the lighting circuit of a controller display.	Controller screen lighting is switched off or a portable transceiver is kept away 1m or more.

6.6.3 Repair units/parts

The repair units and replacement part units are as follows.

● NTE-770S/780D VHF TRANSCEIVER

Name	Unit/Part Name	Notes
CONTROL & AF UNIT	CDJ-7701S/ 7701D	Suffix S: for 770S, D: for 780D
TRX UNIT	CMN-7701S/ 7701D	Suffix S: for 770S, D: for 780D
TERMINAL BOARD	CBD-7701	
DUPLEXER	CFF-851	For the NTE-780D only
EXTENSION BOARD	CQD-7701	Option
TRX ANT CABLE	7ZCJD0291	1.5D coaxial (350mm)
WKR ANT CABLE	7ZCJD0292	1.5D coaxial (300mm)
FUSE	MF61NR 250V 15	15A, for F1 *
FUSE	MF61NR 250V 15	15A, for F2 *
FUSE	MF61NR 250V 10	10A, for F3 *

* Containing to the spare parts kit (7ZXJD0096)

● NCM-1770 VHF CONTROLLER

Name	Unit/Part Name	Notes
CONTROL UNIT	CDJ-3770	
AF CONT UNIT	CMV-3770	
LCD UNIT	CDE-3770	
MAIN PANEL UNIT	CCK-3771	
SUB PANEL UNIT	CCK-3772	
SPEAKER	7USJD0002	
CONTROLLER CABLE	7ZCJD0299A	Control cable (5m)

● NBD-865 AC/DC POWER SUPPLY (Option)

Name	Unit/Part Name	Notes
FUSE	MQ4 250V 8A	8A, for AC FUSE
FUSE	MQ4 250V 8A	8A, for AC FUSE
FUSE	FGB1 250V 15A	15A, for F1
FUSE	FGB1 250V 15A	15A, for F2
FUSE	CES14 250V 15A	15A, for F3

6.6.4 Regular replacement parts

The following shows the part to be replaced regularly. Please contact JRC or our agency to order it.

Part Name	Model Name	Replacement Period
LCD unit	CDE-3770	Approx 20,000 hours of continued use at maximum brightness

7. AFTER-SALES SERVICE

★ Warranty

The warranty period is determined by JRC's warranty regulations, but is normally 1 year from the date of purchase.

★ Repair Part Inventory Period

Parts necessary for proper functioning of this equipment will be kept available for 10 years after product discontinuation.

★ When Requesting Repairs

If what appears to be a defect is detected, refer to "6.5 Troubleshooting" to check if the equipment is actually defective.

If the problem is due to a defect, immediately stop use of the system and contact the store at which you purchased the system, or one of our branches.

- During the warranty period, if a malfunction occurs with the equipment while in standard usage in accordance with this instruction manual, we or our agencies will repair the malfunction at no charge at the store at which the equipment was purchased or another location specified by JRC. If the malfunction occurs due to improper usage, fault, fire or natural disasters, JRC will perform repairs on the equipment for a fee.

- After the warranty expires, we will repair the malfunction for a fee, if repair is possible.

- Please inform us of the following.

- ☆ Product name, model name, manufactured date, serial number

- ☆ As much information as you can provide about the malfunction. (Alarm number, whether transmission is possible or not, etc.)

- ☆ Your company or organization name, address, and phone number

★ Periodical Maintenance Recommendation

Depending on usage conditions, with extended use, the performance of this equipment may degrade over time, and externally installed parts such as the antenna may degrade due to vibration, so we recommend periodical maintenance in addition to the standard maintenance.

Please contact the store at which you purchased the equipment, or one of our branches, to request periodical maintenance. Periodical maintenance requires a service charge.

If you have any questions regarding after-sales service, please contact the store at which you purchased the equipment, or one of our branches.

Refer to the inside of the back cover for contact numbers and locations.

8. DISPOSAL

Observe all rules and regulations of the local authorities when disposing of this equipment.

9. SPECIFICATIONS

9.1 JHS-770S/780D Marine VHF Radiotelephone

● General Specifications

Transmission frequency	Simplex/ semi-duplex: 155.000 - 163.500MHz Duplex (JHS-780D) : 156.025 - 157.425MHz
Reception frequency	Simplex/ semi-duplex: 155.000 - 163.500MHz Duplex (JHS-780D) : 160.625 - 162.025MHz
Number of channels	ITU/USA/Canada/IWW channels: Maximum 57 ch Weather channels: 10ch Private channels: Maximum 200ch Memory channels: Maximum 10ch
Channel spacing	25kHz
Communication modes	Simplex , semi-duplex and duplex (JHS-780D) / press talk
Type of emission	Radiotelephone communications: F3E (G3E) DSC/ATIS: F2B (G2B)
Antenna impedance	50Ω unbalanced
Transmission/reception switching interval	300 ms or less
Channel switching interval	5 sec or less
Interface	IEC61162-1 (GPS/AME/RMS) IEC61162-2 (AIS) 600Ω balanced (VDR), 600Ω unbalanced (Ext SP)
Main controls	DSC call transmission (sending and receiving), communication channel settings, transmission power settings, squelch adjustment, volume adjustment, screen adjustment
Power supply voltage	24VDC (21.6VDC - 31.2VDC)
Current consumption	25W transmission: Maximum 8.0A Reception: Maximum 5.0A
Operating temperature range	-15°C - +55°C (for full performance: 0°C - +40°C)
Storage temperature range	-15°C - +55°C
Humidity resistance	No abnormality after standing 4 hours in +40°C, 93% RH
Vibration resistance (3 Axis)	5Hz – 12.5Hz: Full amplitude 3.2mm 12.5Hz – 25Hz: Full amplitude 0.8mm 25Hz – 50Hz: Full amplitude 0.2mm No abnormality after vibration for 15 minutes in each axis No abnormality after testing resonance points for 30 minutes
Continuous operation (Phone)	No abnormality after operating continuously for 8 hours
Continuous operation (DSC, WKR)	No abnormality after operating continuously for 24 hours
Protection rating	IP22 equivalent (Controller panel)
Dimensions and mass	Transceiver unit 240(W)x290(H)x128(D) [excluding projections] Approximately 6.3kg(NTE-770S) / 6.9kg(NTE-780D) Controller unit 230(W)x142(H)x89(D) [excluding projections], Approximately 1.3kg

Specifications

● Transmitter

Antenna output power	8W - 25W (Reduced output: 0.5W - 1W) +20%, -50%
Oscillation method	Frequency synthesizer
Modulation method	Frequency modulation
Carrier frequency error	±1.5kHz or less
Maximum frequency deviation	±5kHz or less
Occupied bandwidth	16kHz or less
Pre-emphasis characteristics	6dB/oct within +1dB, -3dB
Overall distortion	10% or less
Adjacent channel power	-70 dB or 0.2 μW or less
Unwanted emissions in the out-of-band domain	3.125μW or less
Unwanted emissions in the spurious domain	3.125μW or less
Spurious emissions (EN300 338, EN301 925)	9kHz-2GHz: 0.25μW or less 2GHz-4GHz: 1μW or less
Residual modulation	-40dB or less

● Receiver

Receiving system	Double superheterodyne
1st IF	21.4MHz
2nd IF	455kHz
Local oscillation frequency	Reception frequency - 21.4 MHz
Local oscillation method	Frequency synthesizer
Frequency accuracy	±10 x 10 ⁻⁶ or less
Sensitivity (phone)	6dB μV or less (SINAD=20dB)
Sensitivity (DSC)	1% or lower symbol error rate at 0dB μV
Selectivity	6dB bandwidth: 12kHz or more, 70dB selectivity: 25kHz or less
Signal-to-Noise ratio	40dB or more
Audio output variance	3dB or less
De-emphasis characteristics	6dB/oct, within +1dB, -3dB
Co-channel selectivity	-10 - 0dB
Adjacent channel selectivity	Sensitivity ratio 80dB or more
Desensitization effect (phone)	80dBμV or more
Desensitization effect (DSC)	Symbol error rate of 1% or better at a wanted signal level of 3dB μV and an unwanted signal level of 73dB μV
Spurious response (phone)	Sensitivity ratio 70dB or more
Spurious response (DSC)	Symbol error rate of 1% or better at a wanted signal level of 3dB μV and an unwanted signal level of 73dB μV
Intermodulation characteristics (phone)	65dBμV or more
Intermodulation characteristics (DSC)	Symbol error rate of 1% or better at a wanted signal level of 3dB μV and an unwanted signal level of 73dB μV
Blocking characteristics	90dBμV or more
Radiation	9kHz - 2GHz: 2nW or less 2GHz - 4GHz: 20nW or less
Squelch mute	-40dB or less
Squelch open level	+6dBμV or less
Overall distortion	10% or less

● CH70 Watch Keeping Receiver

Receiving frequency	156.525MHz (CH70)
Receiving system	Double superheterodyne
1st IF	58.1MHz
2nd IF	455kHz
Local oscillation frequency	Receiving frequency + 58.1MHz
Local oscillation method	Frequency synthesizer
Local oscillation frequency variance	$\pm 10 \times 10^{-6}$ or less
Sensitivity	1% or lower symbol error rate at 0dB μ V
Selectivity	6dB bandwidth: 12kHz or more, 70dB selectivity: 25kHz or less
De-emphasis characteristics	6dB/oct, within +1dB, -3dB
Co-channel selectivity	Symbol error rate of 1% or better at a wanted signal level of 3dB μ V and an unwanted signal level of -5dB μ V
Adjacent channel selectivity	Symbol error rate of 1% or better at a wanted signal level of 3dB μ V and an unwanted signal level of 73dB μ V
Desensitization effect	Symbol error rate of 1% or better at a wanted signal level of 3dB μ V and an unwanted signal level of 73dB μ V
Spurious response	Symbol error rate of 1% or better at a wanted signal level of 3dB μ V and an unwanted signal level of 73dB μ V
Intermodulation characteristics	Symbol error rate of 1% or better at a wanted signal level of 3dB μ V and an unwanted signal level of 68dB μ V
Blocking characteristics	Symbol error rate of 1% or better at a wanted signal level of 3dB μ V and an unwanted signal level of 93dB μ V
Radiation	9kHz - 2GHz: 2nW or less

● DSC/ATIS Modem

Modulation rate	1200baud $\pm 30 \times 10^{-6}$ or less
Modulation method	FSK
Modulation index	DSC: 2.0 $\pm 10\%$ or less ATIS: 1.0 $\pm 10\%$ or less
Mark frequency (Y)	1300Hz ± 10 Hz or less
Space frequency (B)	2100Hz ± 10 Hz or less
DSC protocol	ITU-R Recommendation M.493-11 (Class A)
DSC operation standards	ITU-R Recommendation M.541-9, M.689-2, M.821-1, M.1080-0
ATIS protocol, operation standards	EN 300 698-1 V1.3.1

● Controller

Communication speed	9600bps or 57.6kbps
Communication interface	RS-485 and RS-232C
Microphone input impedance	150 Ω balanced
Standard modulation input	-54dBm
Rated audio output	Internal speaker (4 Ω): 2W or more Handset phone (150 Ω): 1mW or more
LCD display	3.8 inch FSTN monochrome, 320 x 240 dot, LED backlight

9.2 Channel assignment tables

(1) ITU Channels (ITU-RR Appendix18)

CH	TX (MHz)	RX (MHz)	Simplex	Semi-duplex/ Duplex	Notes
01	156.050	160.650		●	
02	156.100	160.700		●	
03	156.150	160.750		●	
04	156.200	160.800		●	
05	156.250	160.850		●	
06	156.300	156.300	●		For inter-ship communications
07	156.350	160.950		●	
08	156.400	156.400	●		For inter-ship communications
09	156.450	156.450	●		For inter-ship communications
10	156.500	156.500	●		For inter-ship communications
11	156.550	156.550	●		
12	156.600	156.600	●		
13	156.650	156.650	●		For inter-ship communications
14	156.700	156.700	●		
15	156.750	156.750	●		For inter-ship communications
16	156.800	156.800	●		Distress, Safety and Calling
17	156.850	156.850	●		For inter-ship communications
18	156.900	161.500		●	
19	156.950	161.550		●	
20	157.000	161.600		●	
21	157.050	161.650		●	
22	157.100	161.700		●	
23	157.150	161.750		●	
24	157.200	161.800		●	
25	157.250	161.850		●	
26	157.300	161.900		●	
27	157.350	161.950		●	
28	157.400	162.000		●	
60	156.025	160.625		●	
61	156.075	160.675		●	
62	156.125	160.725		●	
63	156.175	160.775		●	
64	156.225	160.825		●	
65	156.275	160.875		●	
66	156.325	160.925		●	
67	156.375	156.375	●		
68	156.425	156.425	●		
69	156.475	156.475	●		For inter-ship communications
70	156.525	156.525	●		For DSC operation only
71	156.575	156.575	●		
72	156.625	156.625	●		For inter-ship communications
73	156.675	156.675	●		
74	156.725	156.725	●		
75	156.775	156.775	●		Fixed at 1W
76	156.825	156.825	●		Fixed at 1W
77	156.875	156.875	●		For inter-ship communications
78	156.925	161.525		●	
79	156.975	161.575		●	
80	157.025	161.625		●	
81	157.075	161.675		●	
82	157.125	161.725		●	
83	157.175	161.775		●	
84	157.225	161.825		●	
85	157.275	161.875		●	
86	157.325	161.925		●	
87	157.375	157.375	●		
88	157.425	157.425	●		

Notes

The previous reception frequencies for CH87 and CH88 (161.975MHz and 162.025MHz) have been changed to dedicated AIS frequencies.

(2) USA Channels (FCC 47 CFR Part 80: 80.215, 80.371 and 80.373)

CH	TX (MHz)	RX (MHz)	Simplex	Semi-duplex/ Duplex	Notes
01	156.050	156.050	●		
02					Unused
03					Unused
04					Unused
05	156.250	156.250	●		
06	156.300	156.300	●		For inter-ship communications
07	156.350	156.350	●		
08	156.400	156.400	●		For inter-ship communications
09	156.450	156.450	●		
10	156.500	156.500	●		
11	156.550	156.550	●		
12	156.600	156.600	●		
13	156.650	156.650	●		1W default (momentary 25W)
14	156.700	156.700	●		
15		156.750			Transmission prohibited
16	156.800	156.800	●		Distress, Safety and Calling
17	156.850	156.850	●		
18	156.900	156.900	●		
19	156.950	156.950	●		
20	157.000	157.000	●		For inter-ship communications
21	157.050	157.050	●		For USCG (General use prohibited)
22	157.100	157.100	●		
23	157.150	157.150	●		For USCG (General use prohibited)
24	157.200	161.800		●	
25	157.250	161.850		●	
26	157.300	161.900		●	
27	157.350	161.950		●	
28	157.400	162.000		●	
60					Unused
61					Unused
62					Unused
63	156.175	156.175	●		
64					Unused
65	156.275	156.275	●		
66	156.325	156.325	●		
67	156.375	156.375	●		1W default (momentary 25W)
68	156.425	156.425	●		
69	156.475	156.475	●		
70	156.525	156.525	●		For DSC operation only
71	156.575	156.575	●		
72	156.625	156.625	●		For inter-ship communications
73	156.675	156.675	●		
74	156.725	156.725	●		
75	156.775	156.775	●		Fixed at 1W
76	156.825	156.825	●		Fixed at 1W
77	156.875	156.875	●		For inter-ship communications, fixed at 1W
78	156.925	156.925	●		
79	156.975	156.975	●		
80	157.025	157.025	●		
81	157.075	157.075	●		General use prohibited
82	157.125	157.125	●		General use prohibited
83	157.175	157.175	●		For USCG (General use prohibited)
84	157.225	161.825		●	
85	157.275	161.875		●	
86	157.325	161.925		●	
87	157.375	161.975		●	
88	157.425	157.425	●		For inter-ship communications

Note

The "Unused" channels listed above cannot be set while in the USA channel mode.

Specifications

(3) Canada Channels (INDUSTRY CANADA RBR-2)

CH	TX (MHz)	RX (MHz)	Simplex	Semi-duplex/ Duplex	Notes
01	156.050	160.650		●	
02	156.100	160.700		●	
03	156.150	160.750		●	
04	156.200	156.200	●		For CCG (General use prohibited)
05	156.250	156.250	●		
06	156.300	156.300	●		
07	156.350	156.350	●		
08	156.400	156.400	●		
09	156.450	156.450	●		
10	156.500	156.500	●		
11	156.550	156.550	●		
12	156.600	156.600	●		
13	156.650	156.650	●		
14	156.700	156.700	●		
15	156.750	156.750	●		Fixed at 1W
16	156.800	156.800	●		Distress, Safety and Calling
17	156.850	156.850	●		Fixed at 1W
18	156.900	156.900	●		
19	156.950	156.950	●		For CCG (General use prohibited)
20	157.000	161.600		●	Fixed at 1W
21	157.050	157.050	●		For CCG (General use prohibited)
22	157.100	157.100	●		General use prohibited
23	157.150	161.750		●	
24	157.200	161.800		●	
25	157.250	161.850		●	
26	157.300	161.900		●	
27	157.350	161.950		●	
28	157.400	162.000		●	
60	156.025	160.625		●	
61	156.075	156.075	●		For CCG (General use prohibited)
62	156.125	156.125	●		For CCG (General use prohibited)
63	156.175	156.175	●		
64	156.225	156.225	●		
65	156.275	156.275	●		
66	156.325	156.325	●		
67	156.375	156.375	●		
68	156.425	156.425	●		
69	156.475	156.475	●		
70	156.525	156.525	●		For DSC operation only
71	156.575	156.575	●		
72	156.625	156.625	●		
73	156.675	156.675	●		
74	156.725	156.725	●		
75	156.775	156.775	●		Fixed at 1W
76	156.825	156.825	●		Fixed at 1W
77	156.875	156.875	●		
78	156.925	156.925	●		
79	156.975	156.975	●		
80	157.025	157.025	●		
81	157.075	157.075	●		For CCG (General use prohibited)
82	157.125	157.125	●		For CCG (General use prohibited)
83	157.175	157.175	●		For CCG (General use prohibited)
84	157.225	161.825		●	
85	157.275	161.875		●	
86	157.325	161.925		●	
87	157.375	157.375	●		
88	157.425	157.425	●		

(4) IWW Channels (ETSI EN 300 698-1 V1.3.1)

CH	TX (MHz)	RX (MHz)	Simplex	Semi-duplex/ Duplex	Notes
01	156.050	160.650		●	
02	156.100	160.700		●	
03	156.150	160.750		●	
04	156.200	160.800		●	
05	156.250	160.850		●	
06	156.300	156.300	●		For inter-ship communications, fixed at 1W
07	156.350	160.950		●	
08	156.400	156.400	●		For inter-ship communications, fixed at 1W
09	156.450	156.450	●		
10	156.500	156.500	●		Fixed at 1W
11	156.550	156.550	●		Fixed at 1W
12	156.600	156.600	●		Fixed at 1W
13	156.650	156.650	●		Fixed at 1W
14	156.700	156.700	●		Fixed at 1W
15	156.750	156.750	●		Fixed at 1W
16	156.800	156.800	●		Distress, Safety and Calling
17	156.850	156.850	●		Fixed at 1W
18	156.900	161.500		●	
19	156.950	161.550		●	
20	157.000	161.600		●	
21	157.050	161.650		●	
22	157.100	161.700		●	
23	157.150	161.750		●	
24	157.200	161.800		●	
25	157.250	161.850		●	
26	157.300	161.900		●	
27	157.350	161.950		●	
28	157.400	162.000		●	
60	156.025	160.625		●	
61	156.075	160.675		●	
62	156.125	160.725		●	
63	156.175	160.775		●	
64	156.225	160.825		●	
65	156.275	160.875		●	
66	156.325	160.925		●	
67	156.375	156.375	●		
68	156.425	156.425	●		
69	156.475	156.475	●		
70	156.525	156.525	●		For DSC operation only
71	156.575	156.575	●		Fixed at 1W
72	156.625	156.625	●		For inter-ship communications, fixed at 1W
73	156.675	156.675	●		
74	156.725	156.725	●		Fixed at 1W
75	156.775	156.775	●		Fixed at 1W
76	156.825	156.825	●		Fixed at 1W
77	156.875	156.875	●		For inter-ship communications, fixed at 1W
78	156.925	161.525		●	
79	156.975	161.575		●	
80	157.025	161.625		●	
81	157.075	161.675		●	
82	157.125	161.725		●	
83	157.175	161.775		●	
84	157.225	161.825		●	
85	157.275	161.875		●	
86	157.325	161.925		●	
87	157.375	157.375	●		
88	157.425	157.425	●		

Note

The previous reception frequencies for CH87 and CH88 (161.975MHz and 162.025MHz) have been changed to dedicated AIS frequencies.

Specifications

(5) Weather Channels (FCC Rule 47CER80.371(c) and 80.373(f))

CH	RX (MHz)	Notes
WX1	162.550	NOAA weather channel
WX2	162.400	NOAA weather channel
WX3	162.475	NOAA weather channel
WX4	162.425	NOAA weather channel
WX5	162.450	NOAA weather channel
WX6	162.500	NOAA weather channel
WX7	162.525	NOAA weather channel
WX8	161.650	CANADA CMB service
WX9	161.775	CANADA CMB service
WX0	163.275	NOAA weather channel (Assigned only)

(6) Private Channels (For fishing or specially assigned channels)

CH	Simplex/Semi-duplex	Frequency (MHz)
P001 - P200	Common to both simplex and semi-duplex	155.0000 - 163.5000

Note

- Register the frequencies in 10kHz, 12.5kHz or 25kHz steps.
- If TX and RX frequencies are different, the equipment will be in semi-duplex mode.
- Private channels are registered at the installation of the equipment. If desired to add the other private channels after installation, contact JRC or our agency.

9.3 Options

(1) AC/DC Power supply (NBD-865)

Source voltage	100VAC - 120VAC or 200VAC - 240VAC (50/60Hz) and 24VDC (21.6VDC - 31.2VDC)
Output voltage	24VDC (19.0VDC - 34.0VDC)
Maximum output current	10.5A
Source switching function	Automatic switching to DC power when AC power is cut off (uninterrupted output) Automatic switching from DC to AC when AC power is restored
Temperature range for full performance	-15°C - +55°C
Operating temperature range	-15°C - +55°C
Storage temperature	-25°C - +65°C
Humidity resistance	No abnormality after standing 4 hours in +40 °C, 93% RH
Vibration resistance (3 Axis)	5Hz – 12.5Hz: Full amplitude 3.2mm 12.5Hz – 25Hz: Full amplitude 0.8mm 25Hz – 50Hz: Full amplitude 0.2mm No abnormality after vibration for 15 minutes in each axis No abnormality after testing resonance points for 30 minutes
Continuous operation	No abnormality after operating continuously for 8 hours

(2) VHF Channel selector (NCM-2000)

Main controls	Communication channel settings, transmission power switching settings, volume adjustment, screen adjustment
Communication speed	9600bps or 57.6kbps
Communication interface	RS-485 and RS-232C
Microphone input impedance	150 Ω balanced
Standard modulation input	-54dBm
Audio output	Handset phone (150Ω): 1mW or more
Display	7 segment red LED
Power voltage	15VDC (11.7VDC - 15.0VDC)
Current consumption	Maximum 0.6A

(3) Printer (NKG-91)

Printing system	Thermal line dot
Communication interface	RS-232C, 4.8k/9.6k/38.4kbps
Data control	RTS/CTS
Data buffer	4096byte
Maximum print speed	20mm/sec or more
Roll paper width	58mm
Power voltage	6.5VDC (5VDC - 8.7VDC)
Current consumption	Maximum 2A

9.4 Peripheral interfaces

(1) GPS or other navigation aids interface

Interface standard	NMEA0183/IEC61162-1 compliant
Protocol	4800bps, start 1bit, data 8bit, stop 1bit Non parity
Input sentence	NMEA0183 V1.5: GGA/GLL/RMC V2.0: GGA/GLL/RMC/ZDA V2.3: GGA/GLL/RMC/GNS/ZDA (Talker = "GP" or other)
Applied data type	Ship position & the time information: GGA/GNS/GLL/RMC Date information: ZDA/RMC Equipment time information: ZDA/GGA/GNS/GLL/RMC

(2) AIS interface

Interface standard	IEC61162-2 compliant
Protocol	38.4kbps, start 1bit, data 8bit, stop 1bit No parity
Input sentence/message	VDM sentence: VDL1-5, 9, 18, 19 VDO sentence: VDL1-3, 18 ALR sentence: 003, 004, 026, 062, 065 (Talker = "AI" only)
Data type	Name and identification number of other ship Position information of other ship AIS type (Class A/B/Base station, SAR) Position data for own ship

(3) RMS interface

Interface standard	IEC61162-1 compliant
Protocol	4800bps, start 1bit, data 8bit, stop 1bit No parity
Output message	IEC61162-1 compliant proprietary sentence \$PJRCL sentence (for RMS log saving) \$PJRCM sentence (Device ID = "CV")
Data type	Device model name, serial number, self-diagnosis information, etc.

10. OPTIONS OPERATION

10.1 Handset connection box (NQE-1845/ 1846/ 1847)

There are three types of handset connection boxes: a waterproofed flush mount type for a wing console (NQE-1845), a waterproofed wing installation type (NQE-1846) and an indoor flush mount type (NQE-1847).



CAUTION



Close the water-resistant cap of the waterproof type handset box after use. Rain and sea breeze could cause connector malfunction. Also do not leave the handset above deck.

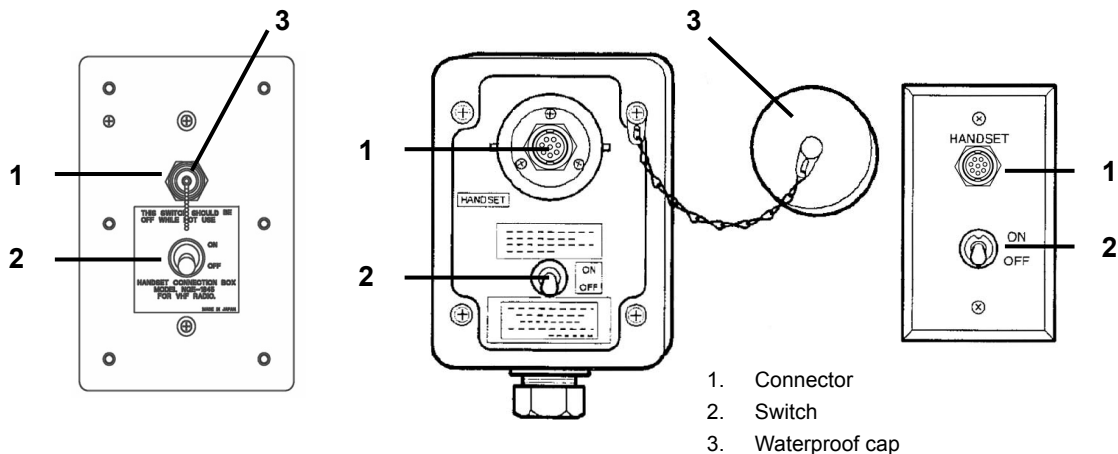

Waterproofed
flush mount type
for wing console
(NQE-1845)

Waterproofed
wing installation type
(NQE-1846)

Indoor flush mount type
(NQE-1847)

■ Procedure ■

1. In the case of the waterproof type, remove the water-resistant cap.
2. Connect the handset (NQW-261) to the connector.
3. Turn ON the switch to start communications.

The access right will be obtained by turning on this switch.
(This switch is equivalent to hook switch of the handset.)

Note

- Always turn off the switch when not in use.
- Even if the switch is turned on, while another controller with higher priority will be in use, the access right will not be obtained.

10.2 AC/DC Power supply (NBD-865)

WARNING



Before replacing fuses of this unit, always turn off this AC/DC power switch and power source output to this unit.



Always use the specified fuse when replacing a fuse. Using a different fuse may result in fire or malfunction.



In addition to the AC fuse on the panel, there are also DC fuses contained in the unit. Opening and working with the inside of the unit may result in fire or electrocution, so with the exception of qualified service personnel, do NOT attempt to replace the DC fuses. To replace the DC fuses, contact JRC or our agent.

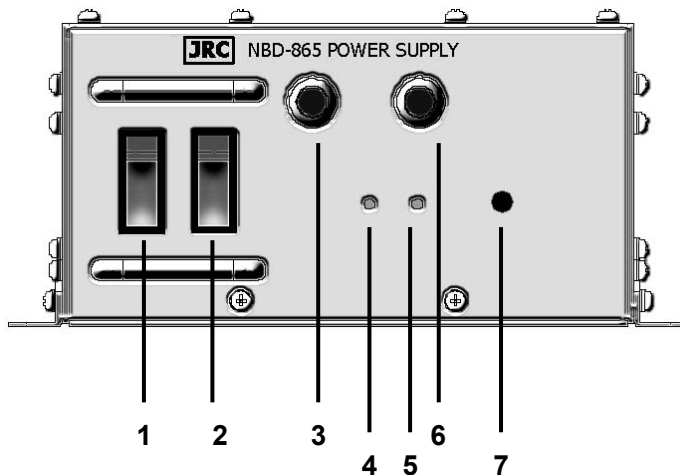

1. AC Switch
2. DC Switch
3. AC Fuse (u)
4. DC OUTPUT Lamp
5. DC OPERATION Lamp
6. AC Fuse (v)
7. Dimmer control

■ Procedure ■

1. Turn on both of the AC and DC switches.

If there is no AC power connected, only turn on the DC power switch.

2. Confirm that the DC OUTPUT lamp is lit.

If this lamp is lit, 24VDC power is being output properly.

Note

- If the switch is turned on but the DC OUTPUT lamp does not light, except for the dimmer control position, there may be a malfunction with the AC/DC input power voltage, or a fuse may have been blown.
- If only DC power is used, the DC OPERATION lamp will light. Be careful not to over discharge the battery.

10.3 Printer (NKG-91)



CAUTION



The thermal head of the printer may be very hot after printing. Do not touch it. Perform paper replacement and head cleaning only after waiting for the head to completely cool.



The printing paper used in this printer is a heat sensitive paper. Take the following precautions when using this paper.

- Store the paper away from heat, humidity, or heat sources.
- Do not rub the paper with any hard objects.
- Do not place the paper near organic solvents.
- Do not allow the paper to come in contact with polyvinyl chloride film, erasers, or adhesive tape for long periods of time.
- Keep away the paper from freshly copied diazo type or wet process copy paper.

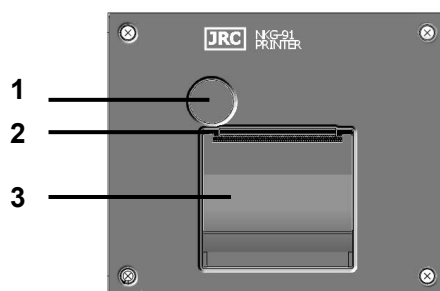

1. Paper cover open button
2. Paper cutter
3. Paper cover

■ Loading the printer paper ■

1. Press the paper cover open button.

The paper cover will open.

2. Insert the paper as shown in the diagram at right.

Position the paper such that the edge extends outside the printer, and press the both sides of the paper cover to close it.

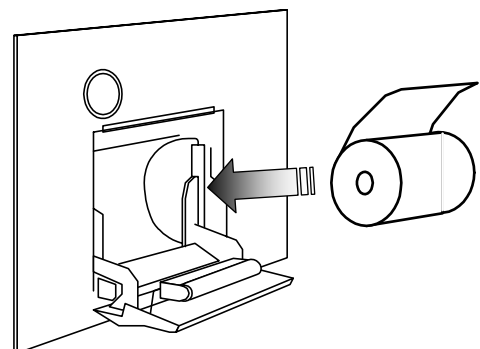

Note

The printer will be turned on and off simultaneously with the radiotelephone.

10.4 VHF Channel selector (NCM-2000)

CAUTION



For channel selectors installed above deck, close the water-resistant cap after use. Rain and sea breeze could cause connector malfunction. Also do not leave the handset above deck.

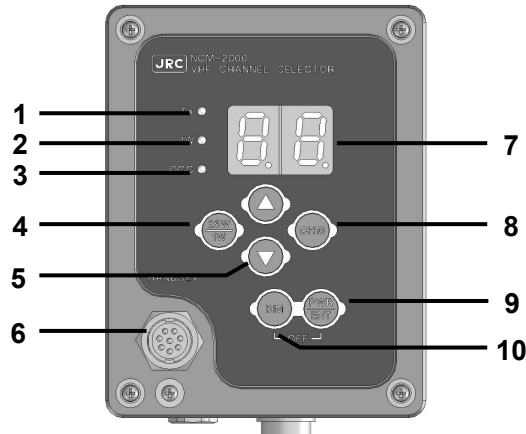

1. TX Lamp
Lights when transmitting.
2. 1W Lamp
Lights when transmitting power is 1W.
3. OCC Lamp
Lights when not having the access right.
4. 25W/1W Switch
Switches transmitting power between 25W and 1W. If pressed and held for two seconds, this unit becomes to the menu mode. In this mode, select the desired item with the ▲ or ▼ key and press ENT, then perform the procedure in the table below. When finishing this menu mode, press and hold for two seconds again.

Display	Setting	Setting Method
S.1	Squelch level	Select 01 (open) - 32 with the ▲ or ▼ key, and press ENT.
S.2	PHONE level	Select 01 - 08 with the ▲ or ▼ key, and press ENT.
S.3	Hook switch detection function	Select ON/OFF with the ▲ or ▼ key, and press ENT.
S.4	Fine brightness	1) Select a brightness level from bright (d.1), medium (d.2), or dark (d.3) with the ▲ or ▼ key, and press ENT. 2) Select the fine brightness value (01-10) for the brightness level selected in 1) with the ▲ or ▼ key, and press ENT.
S.5	Software version	Display a software version.
S.0	(Ends the menu mode.)	-----

5. UP/DOWN arrow keys

These keys are used for channel selection, or menu settings.

6. Waterproof connector cap





When using this unit, remove this cap and connect the handset to the internal connector.

7. Display

Displays the current channel, menus, etc.

Note

- A lower right dot lights up at the time of squelch opened.
- A lower middle dot lights up at the time of selection of duplex-channel.
- Private channel and weather channel cannot be changed.
- When weather channel, PA use, intercom use and such as unlock alarm occurred, display will be "--".

• Squelch open	→	
• Duplex channel	→	
• Private channel	→	
• Weather channel, etc.	→	

8. CH16 key

Sets the radiotelephone channel to CH16.

9. PWR/ENT key

In addition to turning on the power, this key is used to determine the menu items, or to obtain the access right.

10. DIM (brightness control) key

This key cycles the display brightness between bright, medium, dark, and off. If pressed at the same time as the PWR/ENT key, it activates sleep mode.

Note

- The brightness level will not be saved. So when the unit is powered off and on, this level will be at the default medium setting.
- The channel selector cannot change the channel region mode (ITU/USA/Canada/Inland Waterway). When changing the channel region mode, use the controller (NCM-1770).
- The following alarm will be displayed if an error is detected in the channel selector. When the alarm is displayed, contact JRC or our agency.

Alarm Number	Contents
E1	Detected the memory (ROM1) error.
E2	Detected the memory (ROM2) error.
E3	Detected the serial communication test error at powering on.
E4	Detected the serial communication error.

电子信息产品有害物资申明

日本无线株式会社

Declaration on toxic & hazardous substances or elements of Electronic Information Products Japan Radio Company Limited

有毒有害物质或元素的名称及含量

(Names & Content of toxic and hazardous substances or elements)

形式名(Type): JHS-770S / 780D

名称(Name): Marine VHF Radiotelephone

部件名称 (Part name)	有毒有害物质或元素 (Toxic and Hazardous Substances and Elements)					
	铅 (Pb)	汞 (Hg)	镉 (Cd)	六价铬 (Cr ⁶⁺)	多溴联苯 (PBB)	多溴二苯醚 (PBDE)
天线 (Antenna)	×	○	×	×	×	×
船内装置 (Inboard Unit)	×	○	×	×	×	×
外部设备(Peripherals) ·选择(Options) ·打印机(Printer) ·电线类(Cables) ·手册(Documentts)	×	○	×	×	×	×
<p>○: 表示该有毒有害物质在该部件所有均质材料中的含量均在SJ/T11306-2006 标准规定的限量要求以下。 (Indicates that this toxic, or hazardous substance contained in all of the homogeneous materials for this part is below the requirement in SJ/T11363-2006.)</p> <p>×: 表示该有毒有害物质至少在该部件的某一均质材料中的含量超出SJ/T11363-2006 标准规定的限量要求。 (Indicates that this toxic or hazardous substance contained in at least one of the homogeneous materials used for this part is above the limit requirement in SJ/T 11363-2006.)</p>						

JRC Code No. : 7ZPJD0406

アスベストは使用していません
Not use the asbestos

CODE No.7ZPJ0406A

For further information, contact:



Since 1915

Japan Radio Co., Ltd.

URL <http://www.jrc.co.jp>

Marine Service Department

Telephone : +81-3-3492-1305

Facsimile : +81-3-3779-1420

e-mail : tmsc@jrc.co.jp

AMSTERDAM Branch

Telephone : +31-20-658-0750

Facsimile : +31-20-658-0755

e-mail : service@jrcams.nl

SEATTLE Branch

Telephone : +1-206-654-5644

Facsimile : +1-206-654-7030

e-mail : service@jrcamerica.com

01ETM

ISO 9001, ISO 14001 Certified

©JUL. 2009 Edition 2 JRC

Printed in Japan